

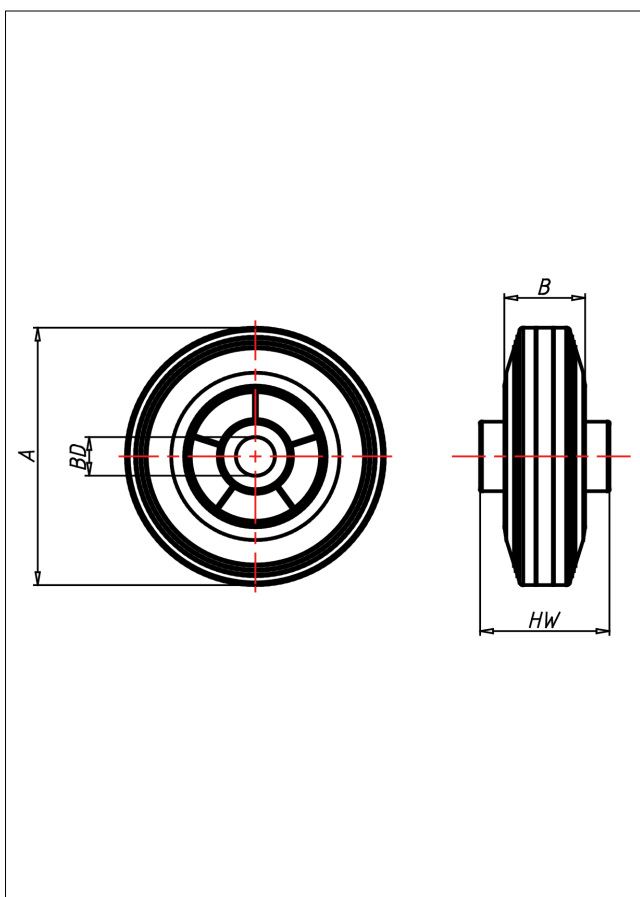

DG Rad

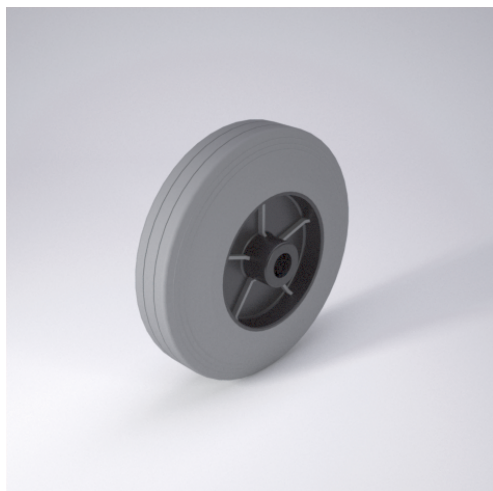

DG



+60 °C
-20 °C max.
kg 320 kg

Radkörper aus hochwertigem schwarzen Kunststoff, Elastik-Vollgummireifen, grau, 75±5 Shore A

- spurfrei - bodenschonend
- ausgezeichneter Fahrkomfort
- sehr lauffähig
- geringer Rollwiderstand
- abriebfest

Technische Details

ORDERNO (Artikel-nummer)	80 DGBX 12
WDAB (Rad-Ø A x Breite B / mm)	80x25
LC (Tragkraft / kg)	55
HW (Nabellänge / mm)	40
FL (Einbaulänge / mm)	40
WB (Radlager)	Edelstahl-Rollenlager
BD (Bohrungsdurchmesser / mm)	12