

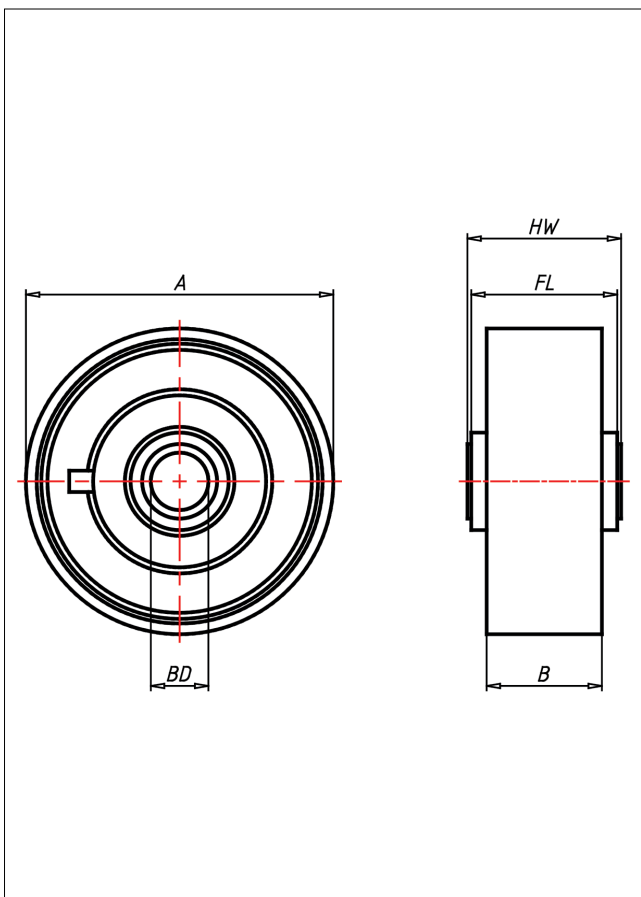

# P Rad

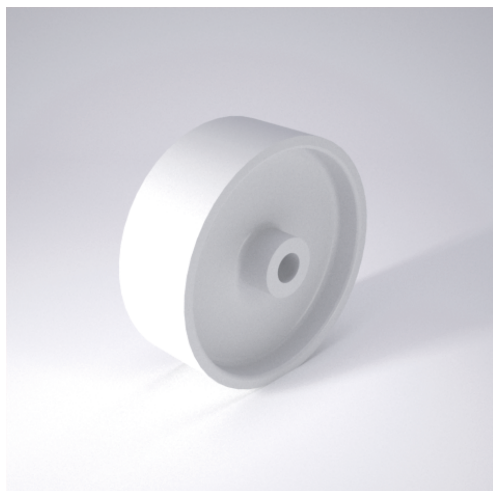

P



+80 °C  
-20 °C max.  
900 kg



Vollrad aus Polyamid 6 - 1. Wahl

- leichter Lauf auf glatten Böden
- stoß- und schlagfest
- hohe Abriebfestigkeit
- leicht zu reinigen
- sehr beständig gegen viele aggressive Medien

## Technische Details

<b>ORDERNO (Artikel-nummer)</b>	80 PB 15
<b>WDAB (Rad-Ø A x Breite B / mm)</b>	80x30
<b>LC (Tragkraft / kg)</b>	150
<b>HW (Nabellänge / mm)</b>	40
<b>FL (Einbaulänge / mm)</b>	40
<b>WB (Radlager)</b>	Rollenlager
<b>BD (Bohrungsdurchmesser / mm)</b>	15