

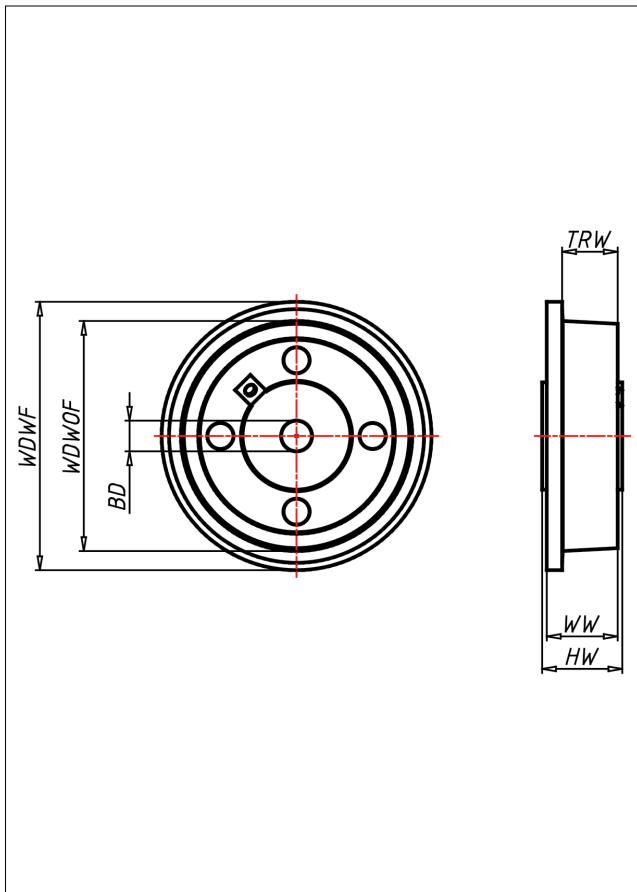

SPA

Spurkranzrad

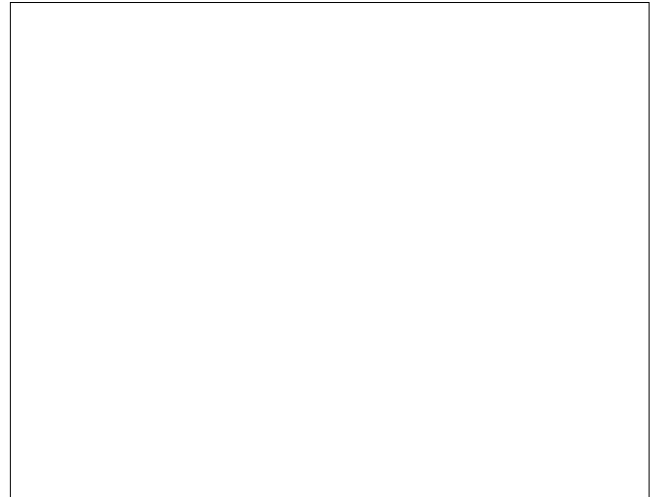

SPA Spurkranzrad



Spurkranzrad aus hochwertigem Polyamid 6
Lauffläche sauber überdreht,
Lauffläche 3° ansteigend

- geringer Rollwiderstand
- hohe Abriebfestigkeit

Technische Details

ORDERNO (Artikel-nummer)	87 SPA-16
WDWOF (Rad-Ø o. Spurkranz / mm)	87
WDWF (Rad-Ø m. Spurkranz / mm)	108
TRW (Laufflächenbreite / mm)	25
WW (Radbreite / mm)	32
LC (Tragkraft / kg)	200
HW (Nabellänge / mm)	32
WB (Radlager)	Gleitlager
BD (Bohrungsdurchmesser / mm)	16