

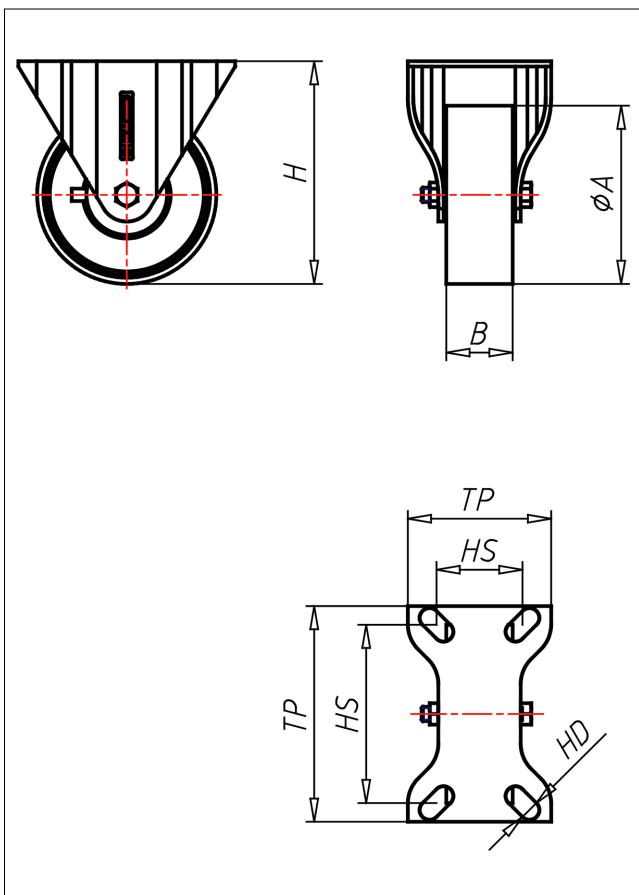

88/81-NY/PK/PB/P

Bockrolle

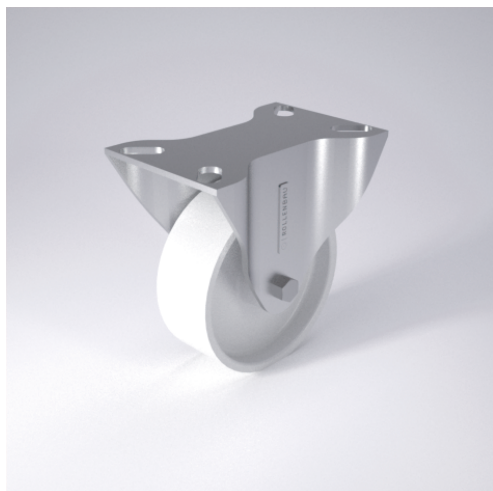

61-P



LENKROLLE	LENKROLLE MIT RADFESTSTELLER	BOCKROLLE																				
<ul style="list-style-type: none"> • leichter Lauf auf glatten Böden • stoß- und schlagfest • hohe Abriebfestigkeit • leicht zu reinigen • sehr beständig gegen viele aggressive Medien <p>Polyamid 6 - 1. Wahl → Seite 222</p>	<p>sehr großes Schwenklager - lange Lebensdauer, Gabelschenkel speziell geformt, Radachse verschraubt - gesichert, verzinkt → Seite 42</p>	<p>AUSWAHLHILFE:</p> <table border="1"> <tr> <td>leicht lenkend</td> <td>X</td> <td>+</td> <td>+</td> </tr> <tr> <td>verschleißarm</td> <td>+</td> <td>+</td> <td>X</td> </tr> <tr> <td>stoßfest</td> <td>+</td> <td>+</td> <td>X</td> </tr> <tr> <td>bodenschonend</td> <td>+</td> <td>+</td> <td>X</td> </tr> <tr> <td>witterungsbeständig</td> <td>X</td> <td>+</td> <td>+</td> </tr> </table>	leicht lenkend	X	+	+	verschleißarm	+	+	X	stoßfest	+	+	X	bodenschonend	+	+	X	witterungsbeständig	X	+	+
leicht lenkend	X	+	+																			
verschleißarm	+	+	X																			
stoßfest	+	+	X																			
bodenschonend	+	+	X																			
witterungsbeständig	X	+	+																			

Technische Details

ORDERNO (Artikel-nummer)	88-126 P
WDAB (Rad-Ø A x Breite B / mm)	125x45
LC (Tragkraft / kg)	475
H (Bauhöhe H / mm)	156
TP (Plattengröße / mm)	121x80
HS (Lochabstand / mm)	100x48
HD (Loch-Ø / mm)	11
WB (Radlager)	Polyamid-Gleitlager