

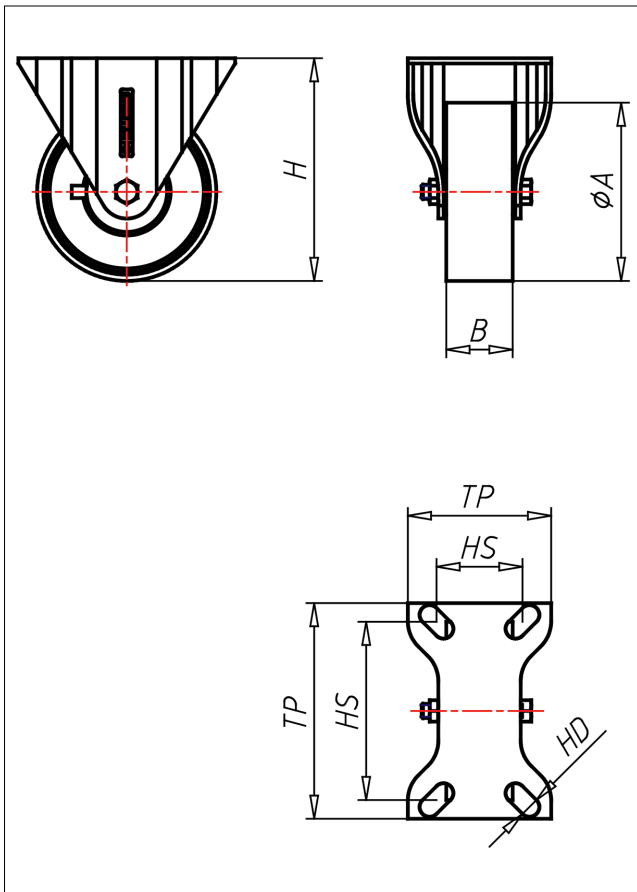

88/81-NY/PK/PB/P

Bockrolle

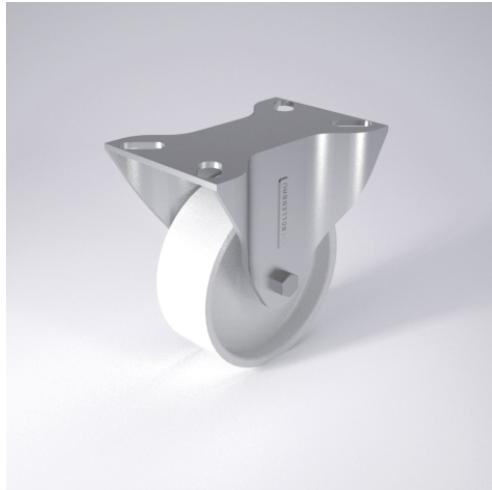

61-P



LENKROLLE	LENKROLLE MIT RADFESTSTELLER	BOCKROLLE															
<ul style="list-style-type: none"> • leichter Lauf auf glatten Böden • stoß- und schlagfest • hohe Abriebfestigkeit • leicht zu reinigen • sehr beständig gegen viele aggressive Medien <p>Polyamid 6 - 1. Wahl → Seite 222</p>	<p>sehr großes Schwenklager - lange Lebensdauer, Gabelschenkel speziell geformt, Radachse verschraubt - gesichert, verzinkt → Seite 42</p>	<p>AUSWAHLHILFE:</p> <table border="0"> <tr> <td>leicht lenkend</td> <td>X</td> <td>X</td> </tr> <tr> <td>verschleißarm</td> <td>●</td> <td>X</td> </tr> <tr> <td>stoßfest</td> <td>●</td> <td>X</td> </tr> <tr> <td>bodenschonend</td> <td>●</td> <td>X</td> </tr> <tr> <td>witterungsbeständig</td> <td>X</td> <td>●</td> </tr> </table>	leicht lenkend	X	X	verschleißarm	●	X	stoßfest	●	X	bodenschonend	●	X	witterungsbeständig	X	●
leicht lenkend	X	X															
verschleißarm	●	X															
stoßfest	●	X															
bodenschonend	●	X															
witterungsbeständig	X	●															

Technische Details

ORDERNO (Artikel-nummer)	88-50 NY
WDAB (Rad-Ø A x Breite B / mm)	50x19
LC (Tragkraft / kg)	50
H (Bauhöhe H / mm)	64
TP (Plattengröße / mm)	70x43
HS (Lochabstand / mm)	54x25
HD (Loch-Ø / mm)	7
WB (Radlager)	Polyamid-Gleitlager