

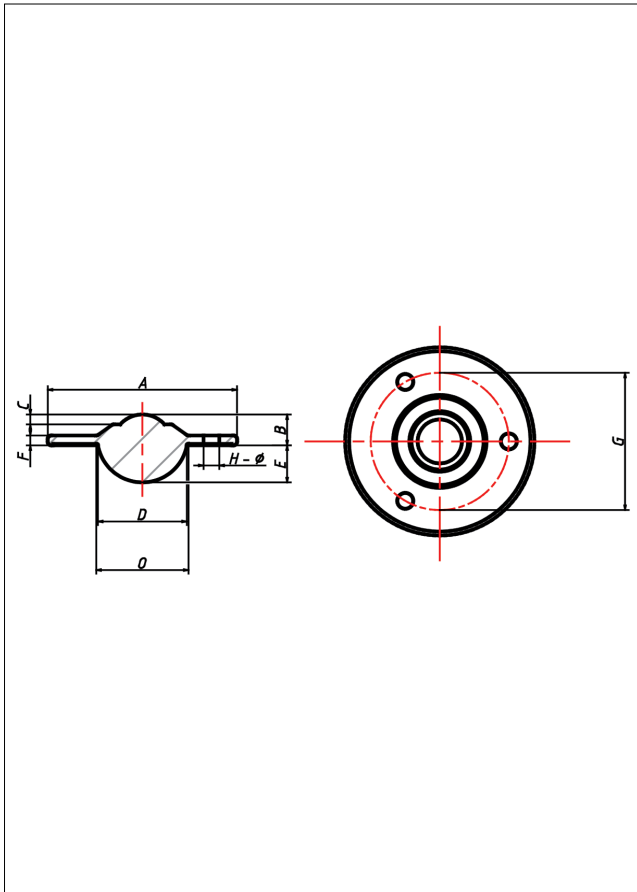

# A-Flange

## Kugelrollen - Flansch



A-Flange Kugelrollen-Flansch

+70 °C  
-30 °C  
max. 340 kg



### Technische Details

ORDERNO (Artikel-nummer)	A1022-13
BALL (Kugel-Ø / mm)	32
NOH (Loch-anzahl)	3
FH (Ausführung Gehäuse)	Stahl verzinkt
FB (Ausführung Kugeln)	verzinkt
LCU (Tragkraft up / kg)	125
LCD (Tragkraft down / kg)	55
A (/ mm)	73.7
B (/ mm)	16.2
C (/ mm)	8
D (/ mm)	45.5
E (/ mm)	19.9