

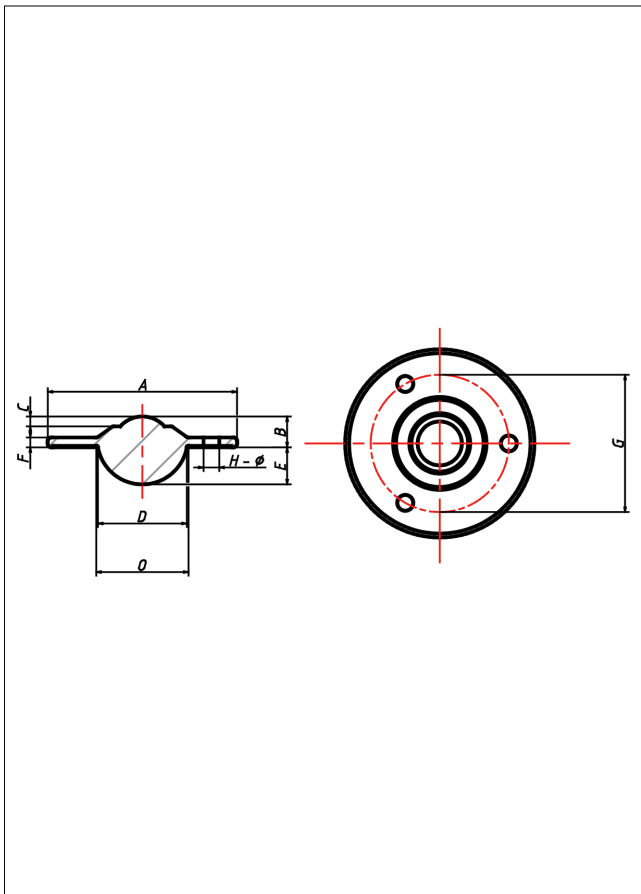

A-Flange

Kugelrollen - Flansch



A-Flange Kugelrollen-Flansch

+70 °C
-30 °C
max. 340 kg



Technische Details

ORDERNO (Artikel-nummer)	A2011-16
BALL (Kugel-Ø / mm)	40
NOH (Loch-anzahl)	3
FH (Ausführung Gehäuse)	Stahl verzinkt
FB (Ausführung Kugeln)	Edelstahl
LCU (Tragkraft up / kg)	140
LCD (Tragkraft down / kg)	60
A (/ mm)	89
B (/ mm)	21.4
C (/ mm)	8.7
D (/ mm)	55.6
E (/ mm)	24.6