

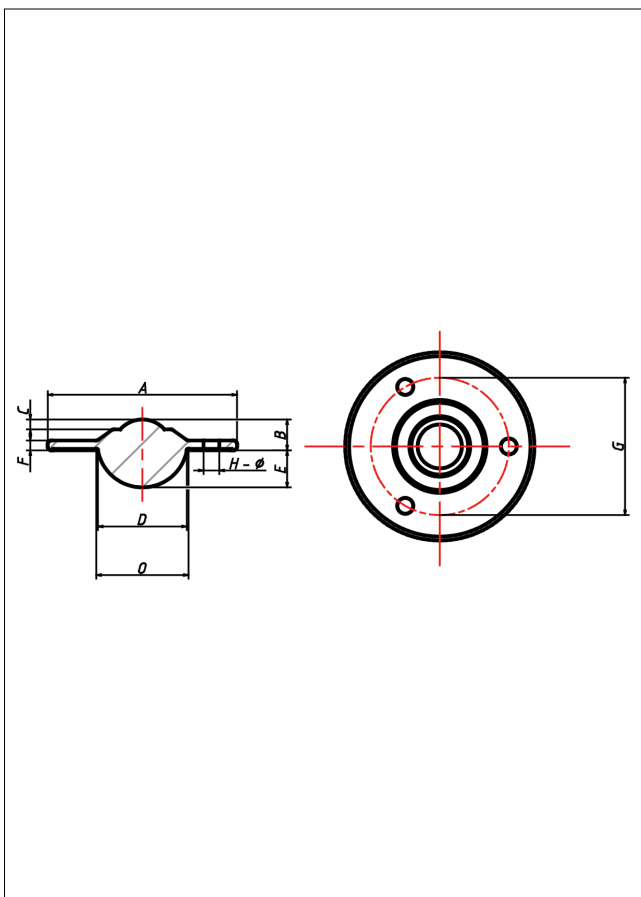

A-Flange

Kugelrollen - Flansch



A-Flange Kugelrollen-Flansch

+70 °C
-30 °C
max. 340 kg



Technische Details

ORDERNO (Artikel-nummer)	A3016-15
BALL (Kugel-Ø / mm)	15
NOH (Loch-anzahl)	2
FH (Ausführung Gehäuse)	Edelstahl
FB (Ausführung Kugeln)	Edelstahl
LCU (Tragkraft up / kg)	12
LCD (Tragkraft down / kg)	6
A (/ mm)	41.3
B (/ mm)	10.2
C (/ mm)	4
D (/ mm)	22.2
E (/ mm)	8.3