

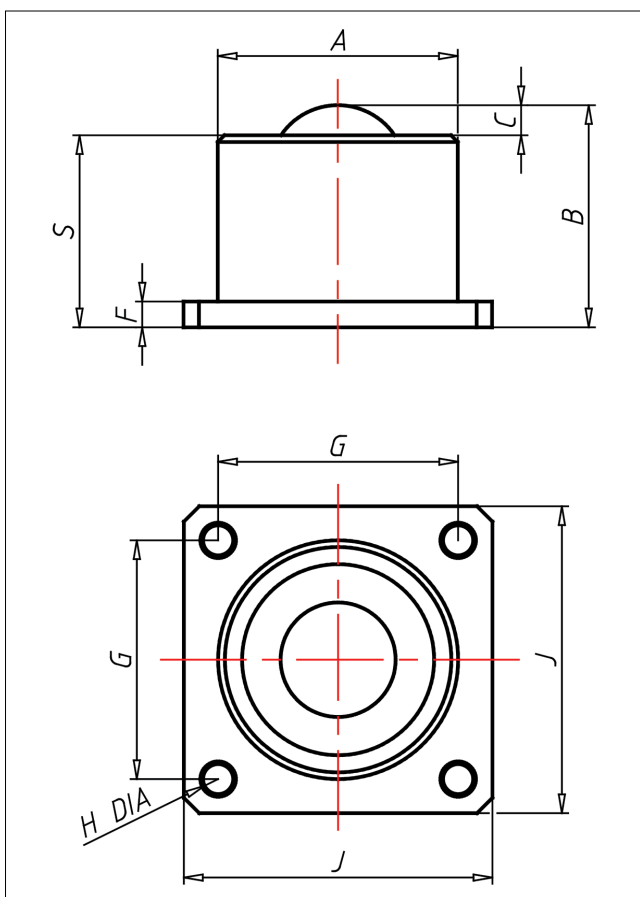

A7

Kugelrollen - Schwerlast

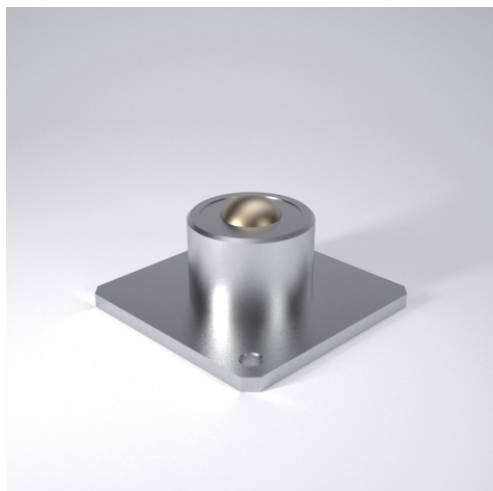

A7 Kugelrollen Schwerlast

+100 °C
-30 °C max.
kg 2000 kg

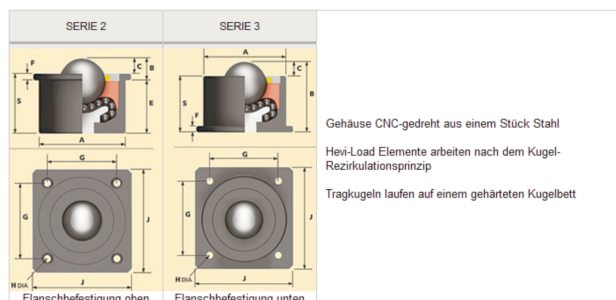

Technische Details

ORDERNO (Artikel-nummer)	A7123-13
BALL (Kugel-Ø / mm)	25.4
SER (Serie)	3
FH (Ausführung Gehäuse)	Stahl
FB (Ausführung Kugeln)	Carbon-Stahl
LC (Tragkraft / kg)	320
A (/ mm)	50.8
B (/ mm)	45.5
C (/ mm)	6.4
E (/ mm)	-
F (/ mm)	6.3
G (/ mm)	57.9