

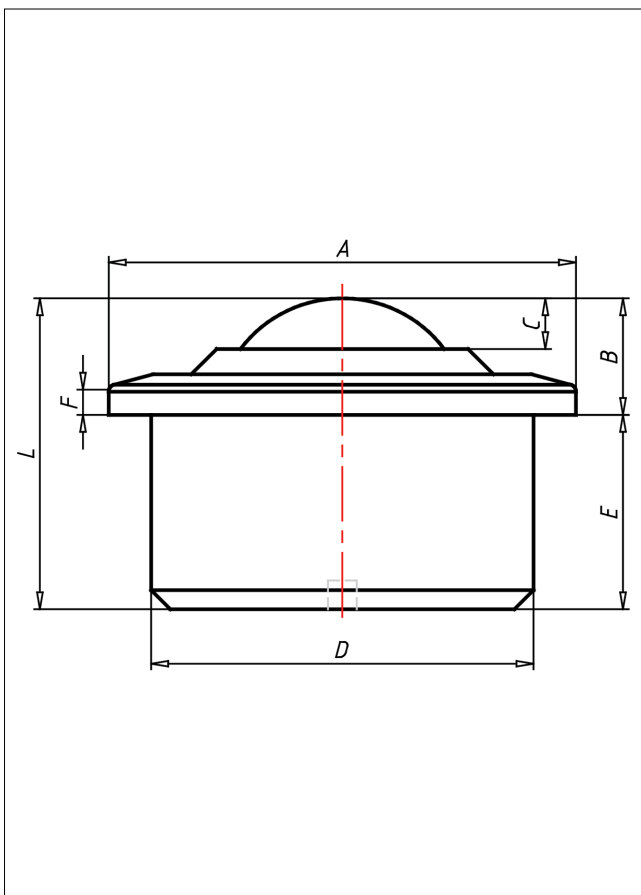

A8

Kugelrollen - Schwerlast



A8 Kugelrollen Schwerlast

+70 °C
-30 °C max.
4000 kg

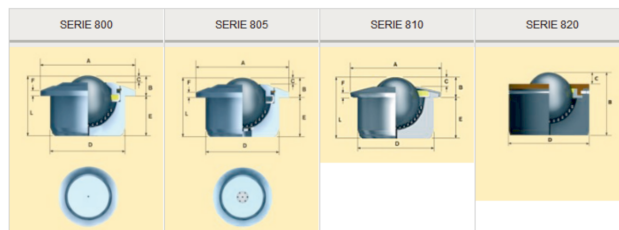

Technische Details

ORDERNO (Artikel-nummer)	A800-45-13
BALL (Kugel-Ø / mm)	45
SER (Serie)	800
FH (Ausführung Gehäuse)	Stahl verzinkt
FB (Ausführung Kugeln)	verzinkt
LC (Tragkraft / kg)	600
A (/ mm)	75
B (/ mm)	19
C (/ mm)	9
D (/ mm)	62
E (/ mm)	34.5
F (/ mm)	3.8