

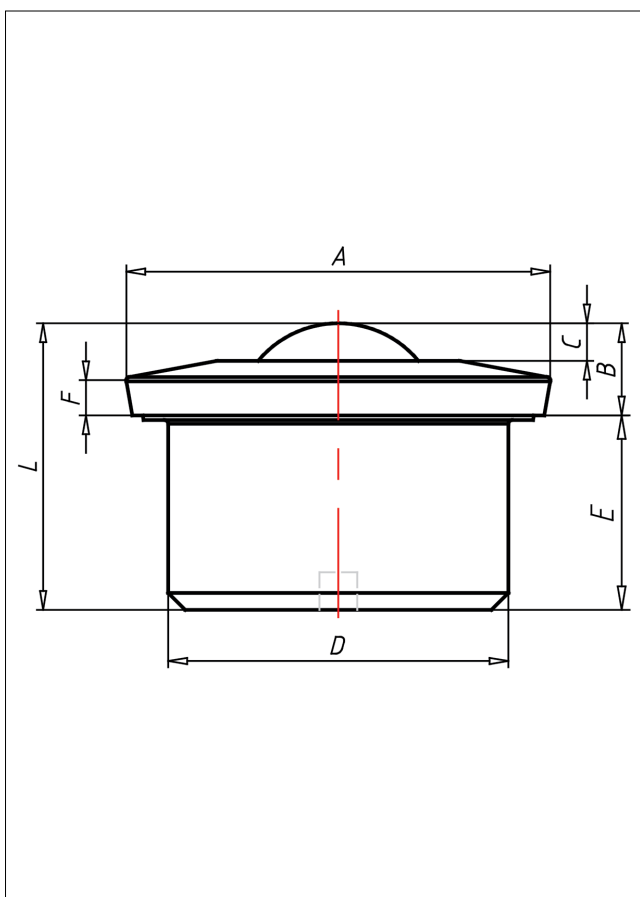

A8

Kugelrollen - Schwerlast



A8 Kugelrollen Schwerlast

+70 °C
-30 °C max.
4000 kg

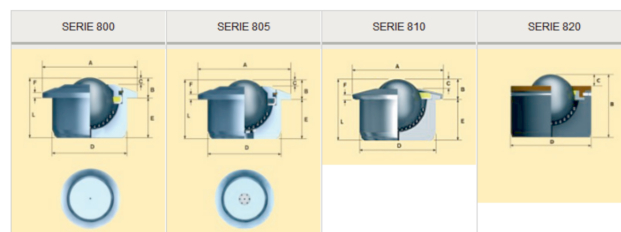

Technische Details

ORDERNO (Artikel-nummer)	A810-15-15
BALL (Kugel-Ø / mm)	15
SER (Serie)	810
FH (Ausführung Gehäuse)	Edelstahl
FB (Ausführung Kugeln)	Edelstahl
LC (Tragkraft / kg)	43
A (/ mm)	31
B (/ mm)	9.5
C (/ mm)	4
D (/ mm)	24
E (/ mm)	11.5
F (/ mm)	3.8