

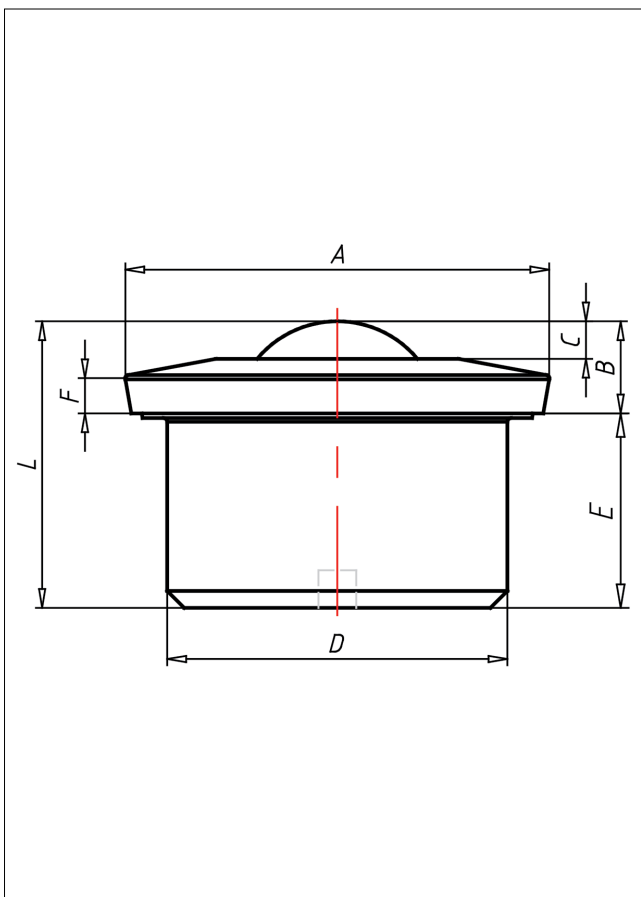

# A8

## Kugelrollen - Schwerlast



### A8 Kugelrollen Schwerlast

+70 °C  
-30 °C max.  
4000 kg

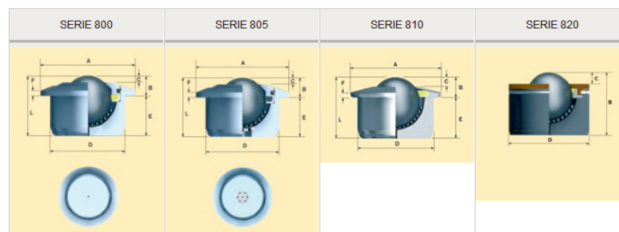

### Technische Details

<b>ORDERNO (Artikel-nummer)</b>	A810-15-16
<b>BALL (Kugel-Ø / mm)</b>	15
<b>SER (Serie)</b>	810
<b>FH (Ausführung Gehäuse)</b>	Stahl verzinkt
<b>FB (Ausführung Kugeln)</b>	Edelstahl
<b>LC (Tragkraft / kg)</b>	56
<b>A (/ mm)</b>	31
<b>B (/ mm)</b>	9.5
<b>C (/ mm)</b>	4
<b>D (/ mm)</b>	24
<b>E (/ mm)</b>	11.5
<b>F (/ mm)</b>	3.8