

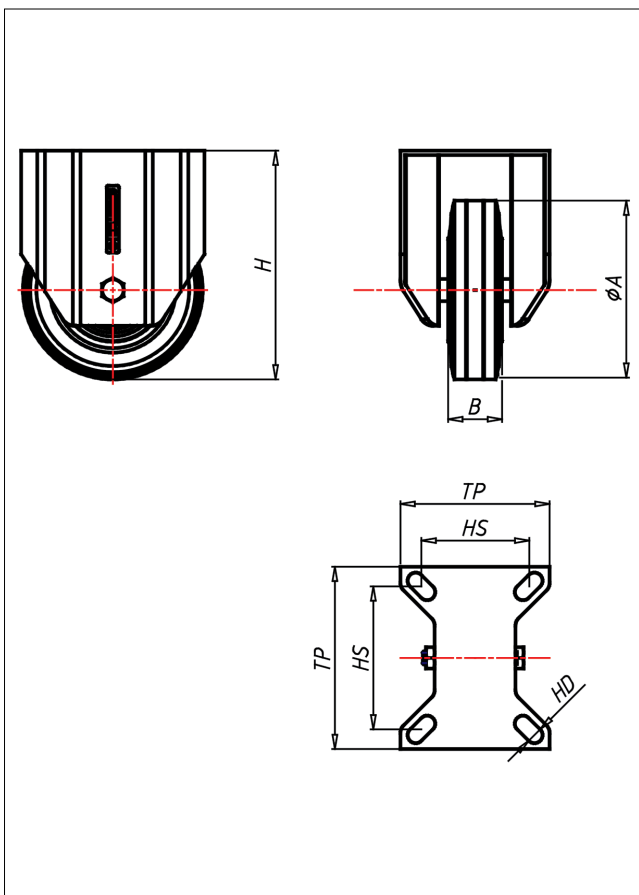

CDF/CFS/CSSF-HB

Bockrolle

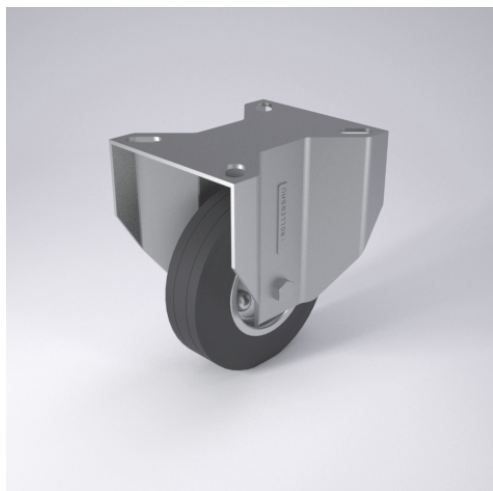

CDH-HB



LENKROLLE		
<ul style="list-style-type: none"> • hitzebeständig • geräuscharmer Lauf • großer Fahrkomfort • beständig gegen verdünnte Säuren Vollgummi schwarz Felge Stahlblech verzinkt verschraubt → Seite 275	zweifaches Kugellager- vernietet Staubschutzring, verzinkt, Radachse verschraubt → Seite 160	AUSWAHLHILFE: <ul style="list-style-type: none"> leicht lenkend <input checked="" type="checkbox"/> verschleißarm <input checked="" type="checkbox"/> stoßfest <input checked="" type="checkbox"/> bodenschonend <input checked="" type="checkbox"/> witterungsbeständig <input checked="" type="checkbox"/>

Technische Details

ORDERNO (Artikel-nummer)	CDF 100 HB
WDAB (Rad-Ø A x Breite B / mm)	100x30
LC (Tragkraft / kg)	80
H (Bauhöhe H / mm)	128
TP (Plattengröße / mm)	102x83
HS (Lochabstand / mm)	80x60
HD (Loch-Ø / mm)	9
WB (Radlager)	Rollenlager