

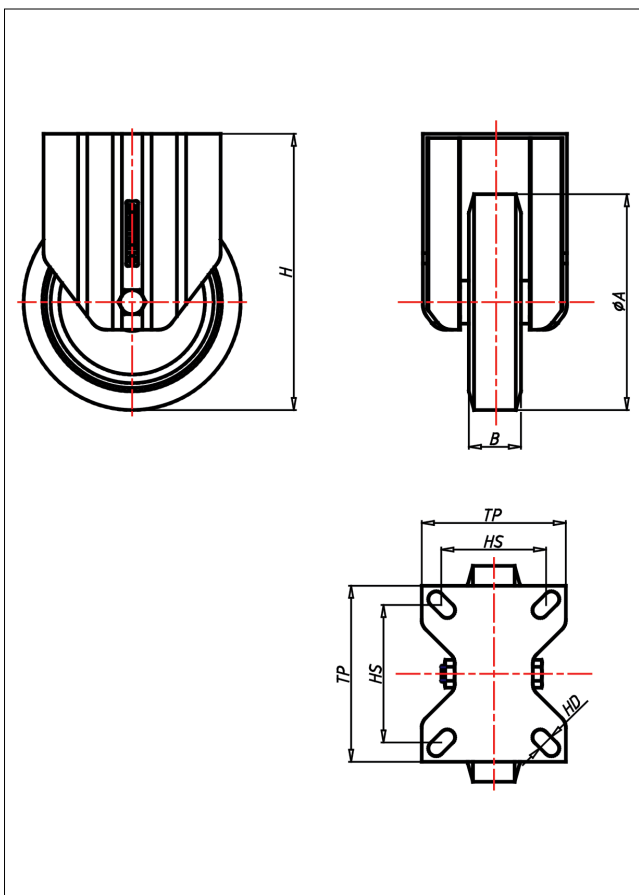

CDF/CSF/CSSF/CLF- A/AK/AB

Bockrolle



CD-A



LENKROLLE	LENKROLLE MIT TOTALFESTSTELLER	BOCKROLLE																				
 <ul style="list-style-type: none"> • geräuscharmer Lauf • geringer Rollwiderstand • abrieb- und reißfest • hohe Stoßfestigkeit • leichte Reinigung • sehr beständig gegen viele aggressive Medien <p>Guss-Polyurethan Felge Polyamid 6 → Seite 252</p> 	  <p>zweifaches Kugellager - vernietet Stahlkugeln gehärtet Dichtungsring, Radachse verschraubt, verzinkt- chrompassiviert</p> <p>→ Seite 62</p>	 <p>AUSWAHLHILFE:</p> <table border="0"> <tr> <td>leicht lenkend</td> <td>+</td> <td>-</td> <td>++</td> </tr> <tr> <td>verschleißarm</td> <td>x</td> <td>x</td> <td>x</td> </tr> <tr> <td>stoßfest</td> <td>+</td> <td>+</td> <td>x</td> </tr> <tr> <td>bodenschonend</td> <td>+</td> <td>+</td> <td>x</td> </tr> <tr> <td>witterungsbeständig</td> <td>x</td> <td>x</td> <td>+</td> </tr> </table>	leicht lenkend	+	-	++	verschleißarm	x	x	x	stoßfest	+	+	x	bodenschonend	+	+	x	witterungsbeständig	x	x	+
leicht lenkend	+	-	++																			
verschleißarm	x	x	x																			
stoßfest	+	+	x																			
bodenschonend	+	+	x																			
witterungsbeständig	x	x	+																			

Technische Details

ORDERNO (Artikel-nummer)	CDF 200 AK
WDAB (Rad-Ø A x Breite B / mm)	200x50
LC (Tragkraft / kg)	300
H (Bauhöhe H / mm)	240
TP (Plattengröße / mm)	135x110
HS (Lochabstand / mm)	105x80
HD (Loch-Ø / mm)	11
WB (Radlager)	Kugellager