

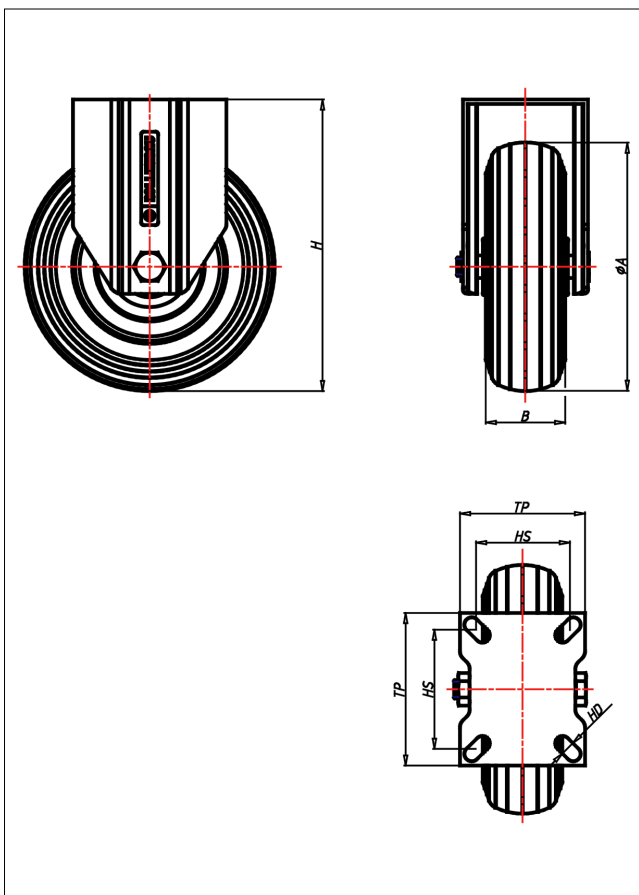

KDF/CDF/EDF- LB/LGB/LSB/LKU/LUK

Bockrolle

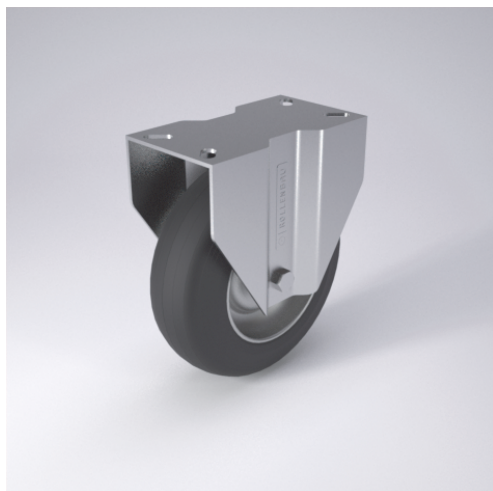

CD-L



LENKROLLE	LENKROLLE MIT TOTALFESTSTELLER	BOCKROLLE																				
<ul style="list-style-type: none"> • hervorragende Stoßdämpfung • minimaler Rollwiderstand • sehr laufruhig • hoher Fahrkomfort • spurfrei in grau <p>Luftreifen mit Schlauch Felge aus Stahlblech oder Kunststoff → Seite 276</p>	<p>zweifaches Kugellager- verschraubt oder vernietet Stahlkugeln gehärtet, Dichtungsring, Radachse verschraubt, verzinkt</p> <p>→ Seite 62</p>	<p>AUSWAHLHILFE:</p> <table border="1"> <tr> <td>leicht lenkend</td> <td>X</td> <td>+</td> <td>++</td> </tr> <tr> <td>verschleißarm</td> <td>X</td> <td>+</td> <td>++</td> </tr> <tr> <td>stoßfest</td> <td>X</td> <td>+</td> <td>++</td> </tr> <tr> <td>bodenschonend</td> <td>X</td> <td>+</td> <td>++</td> </tr> <tr> <td>witterungsbeständig</td> <td>X</td> <td>+</td> <td>++</td> </tr> </table>	leicht lenkend	X	+	++	verschleißarm	X	+	++	stoßfest	X	+	++	bodenschonend	X	+	++	witterungsbeständig	X	+	++
leicht lenkend	X	+	++																			
verschleißarm	X	+	++																			
stoßfest	X	+	++																			
bodenschonend	X	+	++																			
witterungsbeständig	X	+	++																			

Technische Details

ORDERNO (Artikel-nummer)	CDF 220 LB
WDAB (Rad-Ø A x Breite B / mm)	220x70
LC (Tragkraft / kg)	150
H (Bauhöhe H / mm)	258
TP (Plattengröße / mm)	135x110
HS (Lochabstand / mm)	105x80
HD (Loch-Ø / mm)	13
WB (Radlager)	Rollenlager