

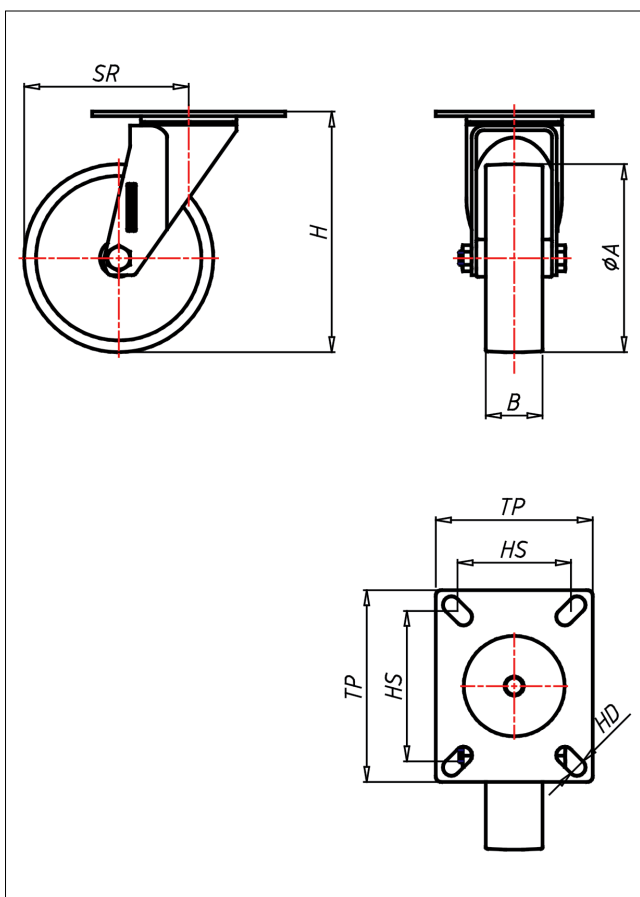

CDH/CSH/CSSH-FS

Lenkrolle



CDH-FS



LENKROLLE																	
 <ul style="list-style-type: none"> • hitze- und kaltebeständig • leichter Lauf auf glatten Böden • stoß- und schlagfest <p>Monoblockrad schwarz</p> <p>→ Seite 274</p>	 <p>zweifaches Kugellager- vernietet Staubschützring, verzinkt, Radachse verschraubt</p> <p>→ Seite 160</p>	<p>AUSWAHLHILFE:</p> <table border="1"> <tr> <td>leicht lenkend</td> <td>+</td> <td>+</td> </tr> <tr> <td>verschleißarm</td> <td>x</td> <td>+</td> </tr> <tr> <td>stoßfest</td> <td>x</td> <td>+</td> </tr> <tr> <td>bodenschonend</td> <td>x</td> <td>+</td> </tr> <tr> <td>witterungsbeständig</td> <td>x</td> <td>+</td> </tr> </table>	leicht lenkend	+	+	verschleißarm	x	+	stoßfest	x	+	bodenschonend	x	+	witterungsbeständig	x	+
leicht lenkend	+	+															
verschleißarm	x	+															
stoßfest	x	+															
bodenschonend	x	+															
witterungsbeständig	x	+															

Technische Details

ORDERNO (Artikel-nummer)	CDH 80 FS
WDAB (Rad-Ø A x Breite B / mm)	80x30
LC (Tragkraft / kg)	150
H (Bauhöhe H / mm)	106
TP (Plattengröße / mm)	102x83
HS (Lochabstand / mm)	80x60
HD (Loch-Ø / mm)	9
SR (Schwenkradius / mm)	73
WB (Radlager)	Gleitlager