

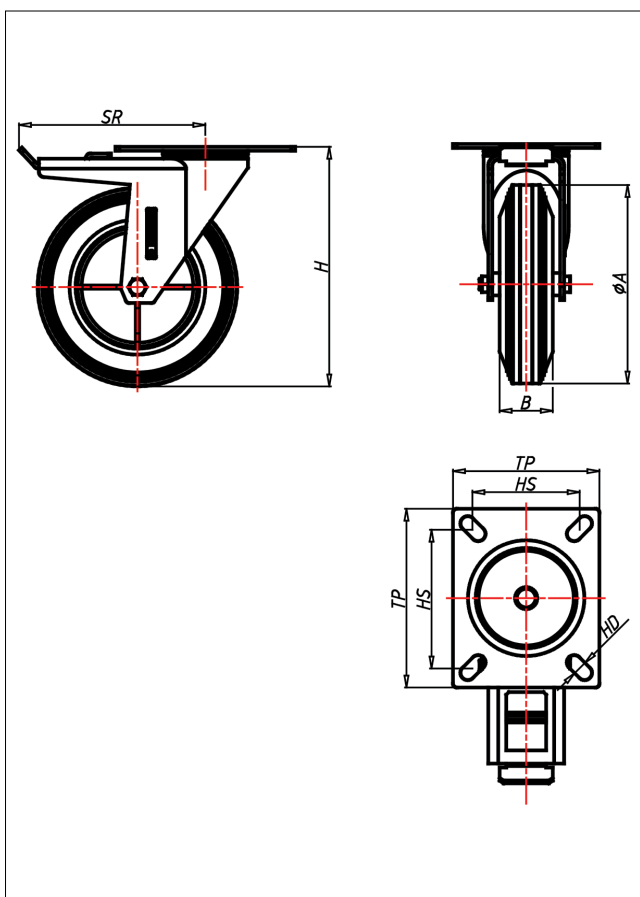

CDT/CST/CLT-CK/CB

Lenkrolle mit Totalfeststeller



CD-C



LENKROLLE	LENKROLLE MIT TOTALFESTSTELLER	BOCKROLLE																				
 <ul style="list-style-type: none"> geräuscharmer Lauf großer Fahrkomfort beständig gegen verdünnte Säuren <p>Vollgummi schwarz Felge Stahlblech verzinkt → Seite 255</p> 	 <p>zweifaches Kugellager - vernietet Stahlkugeln gehärtet Dichtungsring, Radachse verschraubt, verzinkt-chrompassiviert → Seite 62</p>	 <p>AUSWAHLHILFE:</p> <table border="0"> <tr> <td>leicht lenkend</td> <td><input checked="" type="checkbox"/></td> <td><input type="checkbox"/></td> <td><input type="checkbox"/></td> </tr> <tr> <td>verschleißarm</td> <td><input type="checkbox"/></td> <td><input checked="" type="checkbox"/></td> <td><input type="checkbox"/></td> </tr> <tr> <td>stoßfest</td> <td><input type="checkbox"/></td> <td><input checked="" type="checkbox"/></td> <td><input type="checkbox"/></td> </tr> <tr> <td>bodenschonend</td> <td><input type="checkbox"/></td> <td><input type="checkbox"/></td> <td><input checked="" type="checkbox"/></td> </tr> <tr> <td>witterungsbeständig</td> <td><input checked="" type="checkbox"/></td> <td><input type="checkbox"/></td> <td><input type="checkbox"/></td> </tr> </table>	leicht lenkend	<input checked="" type="checkbox"/>	<input type="checkbox"/>	<input type="checkbox"/>	verschleißarm	<input type="checkbox"/>	<input checked="" type="checkbox"/>	<input type="checkbox"/>	stoßfest	<input type="checkbox"/>	<input checked="" type="checkbox"/>	<input type="checkbox"/>	bodenschonend	<input type="checkbox"/>	<input type="checkbox"/>	<input checked="" type="checkbox"/>	witterungsbeständig	<input checked="" type="checkbox"/>	<input type="checkbox"/>	<input type="checkbox"/>
leicht lenkend	<input checked="" type="checkbox"/>	<input type="checkbox"/>	<input type="checkbox"/>																			
verschleißarm	<input type="checkbox"/>	<input checked="" type="checkbox"/>	<input type="checkbox"/>																			
stoßfest	<input type="checkbox"/>	<input checked="" type="checkbox"/>	<input type="checkbox"/>																			
bodenschonend	<input type="checkbox"/>	<input type="checkbox"/>	<input checked="" type="checkbox"/>																			
witterungsbeständig	<input checked="" type="checkbox"/>	<input type="checkbox"/>	<input type="checkbox"/>																			

Technische Details

ORDERNO (Artikel-nummer)	CDT 125 CK
WDAB (Rad-Ø A x Breite B / mm)	125x38
LC (Tragkraft / kg)	120
H (Bauhöhe H / mm)	154
TP (Plattengröße / mm)	102x83
HS (Lochabstand / mm)	80x60
HD (Loch-Ø / mm)	9
SR (Schwenkradius / mm)	108
WB (Radlager)	Kugellager