

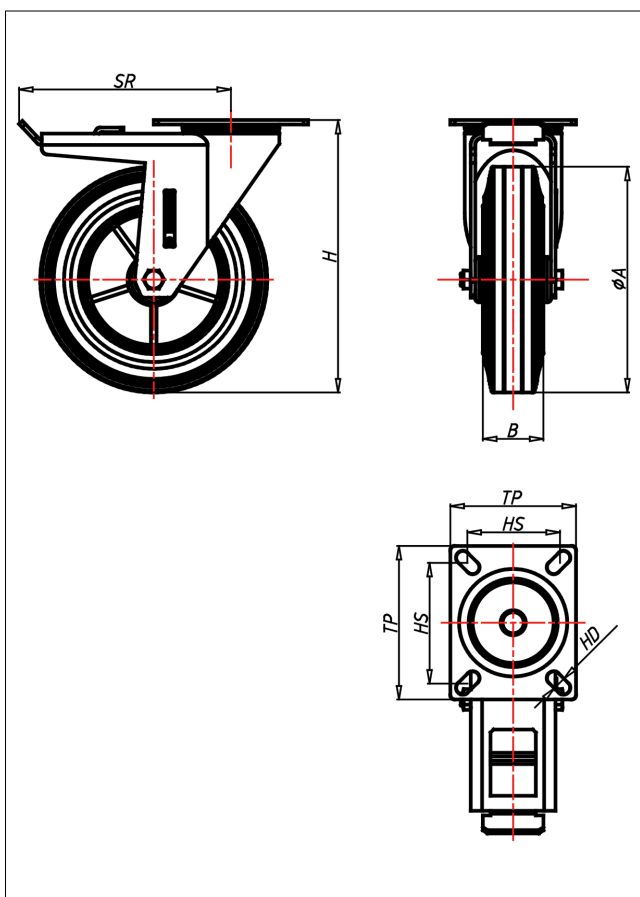

CDT/CLT-DB/D

Lenkrolle mit Totalfeststeller



CD-D



LENKROLLE	LENKROLLE MIT TOTALFESTSTELLER	BOCKROLLE
<ul style="list-style-type: none"> geräuscharmer Lauf großer Fahrkomfort beständig gegen verdünnte Säuren <p>Vollgummi schwarz Felge Kunststoff schwarz → Seite 265</p>	<p>zweifaches Kugellager - vernietet Stahlkugeln gehärtet Dichtungsring, Radachse verschraubt, verzinkt-chrompassiviert → Seite 62</p>	<p>AUSWAHLHILFE: <input type="radio"/> <input checked="" type="radio"/> <input checked="" type="radio"/></p> <p>leicht lenkend <input checked="" type="radio"/> <input checked="" type="radio"/> <input checked="" type="radio"/></p> <p>verschleißarm <input checked="" type="radio"/> <input checked="" type="radio"/> <input checked="" type="radio"/></p> <p>stoßfest <input checked="" type="radio"/> <input checked="" type="radio"/> <input checked="" type="radio"/></p> <p>bodenschonend <input checked="" type="radio"/> <input checked="" type="radio"/> <input checked="" type="radio"/></p> <p>witterungsbeständig <input checked="" type="radio"/> <input checked="" type="radio"/> <input checked="" type="radio"/></p>

Technische Details

ORDERNO (Artikel-nummer)	CDT 150 DB
WDAB (Rad-Ø A x Breite B / mm)	150x40
LC (Tragkraft / kg)	125
H (Bauhöhe H / mm)	181
TP (Plattengröße / mm)	135x110
HS (Lochabstand / mm)	105x80
HD (Loch-Ø / mm)	11
SR (Schwenkradius / mm)	140
WB (Radlager)	Rollenlager