

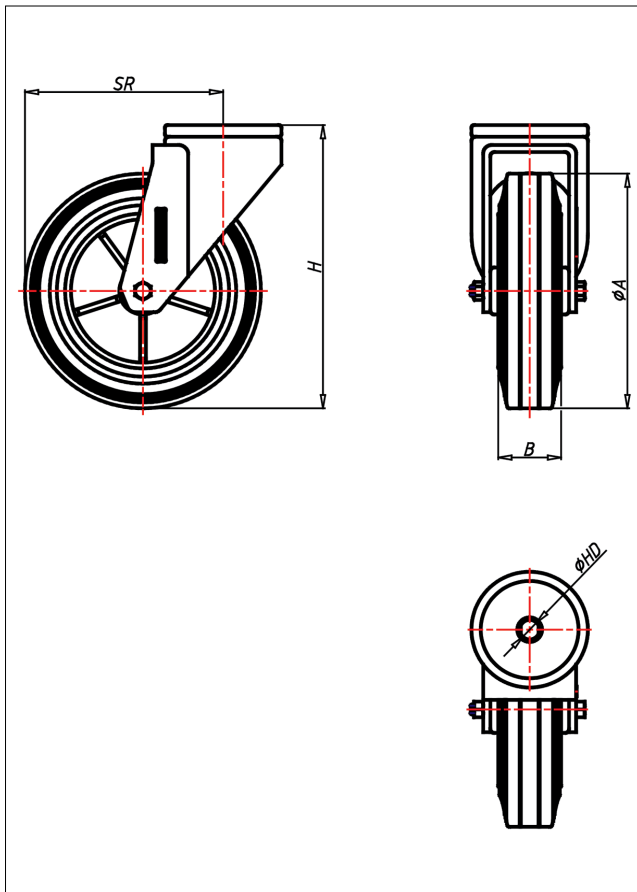

# CR-DB/D

## Lenkrolle



### CR-D



LENKROLLE	LENKROLLE MIT TOTALFESTSTELLER	
<ul style="list-style-type: none"> <li>geräuscharmer Lauf</li> <li>großer Fahrkomfort</li> <li>beständig gegen verdünnte Säuren</li> </ul> Vollgummi schwarz Felge Kunststoff schwarz → Seite 255	<ul style="list-style-type: none"> <li>zweifaches Kugellager - vernietet</li> <li>Stahlkugeln gehärtet</li> <li>Radachse verschraubt, verzinkt</li> </ul> → Seite 62	<b>AUSWAHLHILFE:</b> <ul style="list-style-type: none"> <li>leicht lenkend <input checked="" type="checkbox"/></li> <li>verschleißarm <input checked="" type="checkbox"/></li> <li>stoßfest <input checked="" type="checkbox"/></li> <li>bodenschonend <input checked="" type="checkbox"/></li> <li>witterungsbeständig <input checked="" type="checkbox"/></li> </ul>

### Technische Details

<b>ORDERNO (Artikel-nummer)</b>	CR 100 D
<b>WDAB (Rad-Ø A x Breite B / mm)</b>	100x30
<b>LC (Tragkraft / kg)</b>	75
<b>H (Bauhöhe H / mm)</b>	128
<b>HD (Loch-Ø / mm)</b>	12.5
<b>SR (Schwenkradius / mm)</b>	87
<b>WB (Radlager)</b>	Nylon-Gleitlager