

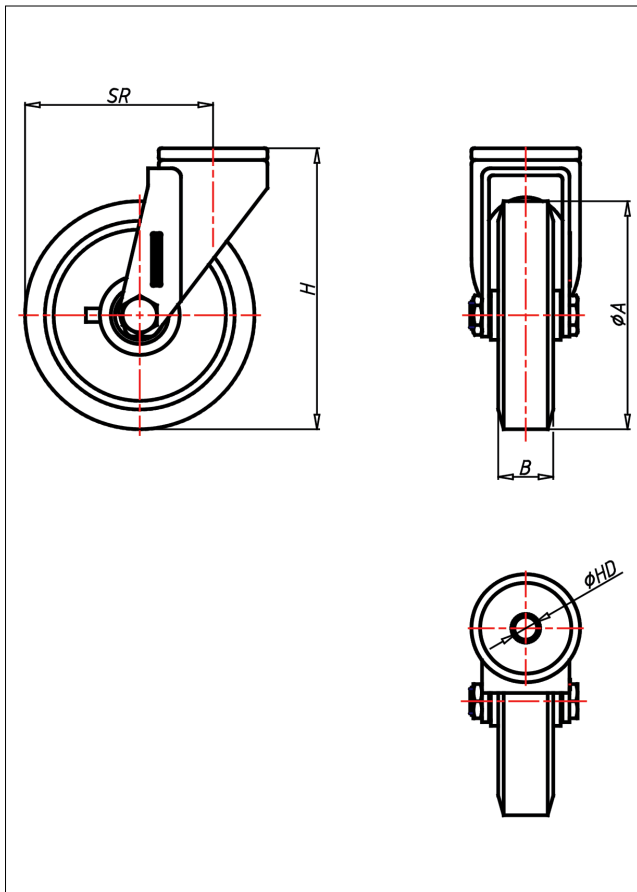

CR/CRS-A/AK/AB

Lenkrolle



CR-A



SWIVEL CASTOR	SWIVEL CASTOR WITH TOTAL LOCK	
<ul style="list-style-type: none"> • silent in motion • low rolling resistance • high abrasion and tear resistance • high resistance to shocks • easy to clean • good chemical resistance Cast-polyurethane High quality nylon wheel centre → page 252	Medium duty bolt hole castor, finish: electro-zinc plated, swivel fork with single bolt hole, double ball bearing - revited, hardened steel balls, wheel axle bolted, total lock → page 62	SELECTION CRITERIA: swivels easily <input type="checkbox"/> <input checked="" type="checkbox"/> <input type="checkbox"/> <input type="checkbox"/> wear resistant <input type="checkbox"/> <input checked="" type="checkbox"/> <input type="checkbox"/> <input type="checkbox"/> shock proof <input type="checkbox"/> <input checked="" type="checkbox"/> <input type="checkbox"/> <input type="checkbox"/> floor protective <input type="checkbox"/> <input type="checkbox"/> <input checked="" type="checkbox"/> <input type="checkbox"/> weather proof <input type="checkbox"/> <input checked="" type="checkbox"/> <input type="checkbox"/> <input type="checkbox"/>

Technische Details

ORDERNO (Artikel-nummer)	CR 80 A
WDAB (Rad-Ø A x Breite B / mm)	80x24
LC (Tragkraft / kg)	120
H (Bauhöhe H / mm)	106
HD (Loch-Ø / mm)	12.5
SR (Schwenkradius / mm)	73
WB (Radlager)	Nylon-Gleittager