

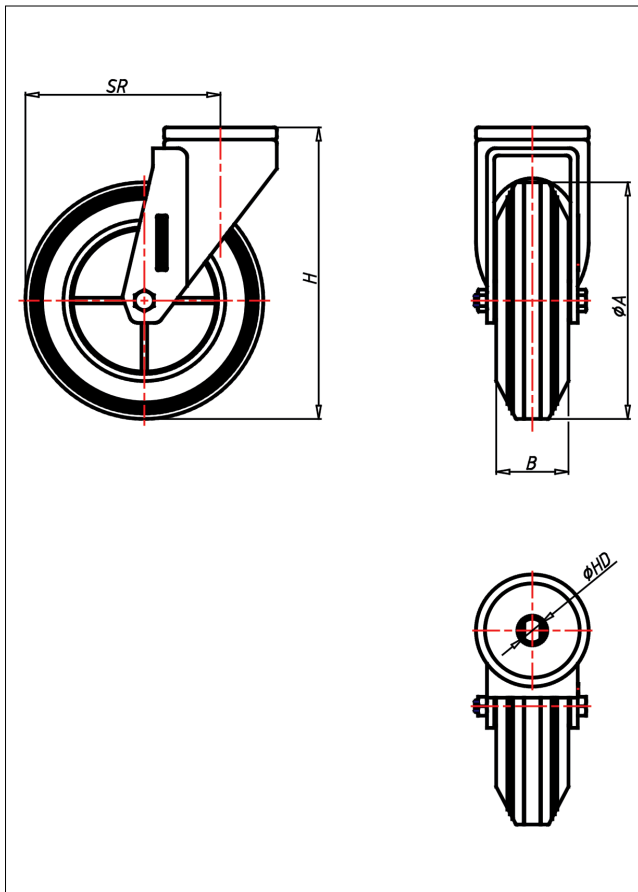

# CR-CGB/CGK

## Lenkrolle



### CR-CG



LENKROLLE	LENKROLLE MIT TOTALFESTSTELLER	
<ul style="list-style-type: none"> <li>• spurfrei - bodenschonend</li> <li>• hoher Fahrkomfort</li> <li>• sehr lauffähig</li> <li>• geringer Rollwiderstand</li> <li>• abriebfest</li> </ul>	<ul style="list-style-type: none"> <li>• zweifaches Kugellager - vernietet</li> <li>• Stahlkugeln gehärtet</li> <li>• Radachse verschraubt, verzinkt</li> </ul>	<p>AUSWAHLHILFE:</p> <ul style="list-style-type: none"> <li>leicht lenkend <input checked="" type="checkbox"/></li> <li>verschleißarm <input checked="" type="checkbox"/></li> <li>stoßfest <input checked="" type="checkbox"/></li> <li>bodenschonend <input checked="" type="checkbox"/></li> <li>witterungsbeständig <input checked="" type="checkbox"/></li> </ul>
<p>ELASTIK-Vollgummi Felge Stahlblech verzinkt → Seite 263</p>	<p>→ Seite 62</p>	

### Technische Details

<b>ORDERNO (Artikel-nummer)</b>	CR 80 CGB
<b>WDAB (Rad-Ø A x Breite B / mm)</b>	80x25
<b>LC (Tragkraft / kg)</b>	70
<b>H (Bauhöhe H / mm)</b>	106
<b>HD (Loch-Ø / mm)</b>	12.5
<b>SR (Schwenkradius / mm)</b>	73
<b>WB (Radlager)</b>	Rollenlager