

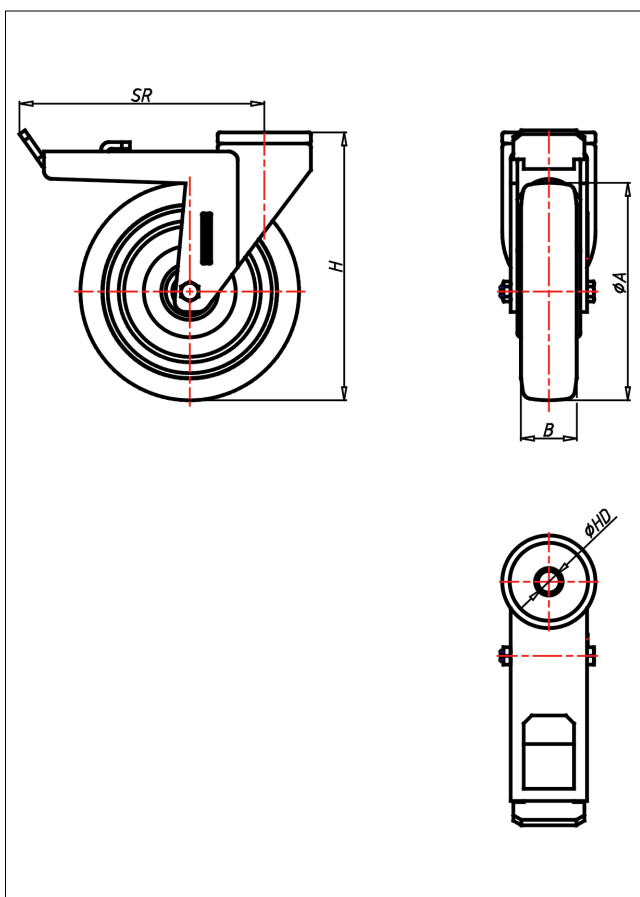

CRT/CRST-AELK

Lenkrolle mit Totalfeststeller



CR-AEL



LENKROLLE	LENKROLLE MIT TOTALFESTSTELLER	
<ul style="list-style-type: none"> • elektrisch leitfähig • geräuscharmer Lauf • geringer Rollwiderstand • spurfrei • hohe Stoßfestigkeit • sehr beständig gegen viele aggressive Medien 	<ul style="list-style-type: none"> • zweifaches Kugellager - vernietet • Stahlkugeln gehärtet • Radachse verschraubt, verzinkt 	<p>AUSWAHLHILFE:</p> <ul style="list-style-type: none"> leicht lenkend <input type="checkbox"/> <input checked="" type="checkbox"/> verschleißarm <input type="checkbox"/> <input checked="" type="checkbox"/> stoßfest <input type="checkbox"/> <input checked="" type="checkbox"/> bodenschonend <input type="checkbox"/> <input checked="" type="checkbox"/> witterungsbeständig <input checked="" type="checkbox"/> <input checked="" type="checkbox"/>
Polyurethan Felge Polyamid 6 → Seite 255	 → Seite 52	

Technische Details

ORDERNO (Artikel-nummer)	CRT 160 AELK
WDAB (Rad-Ø A x Breite B / mm)	160x46
LC (Tragkraft / kg)	200
H (Bauhöhe H / mm)	191
HD (Loch-Ø / mm)	12.5
SR (Schwenkradius / mm)	168
WB (Radlager)	Kugellager