

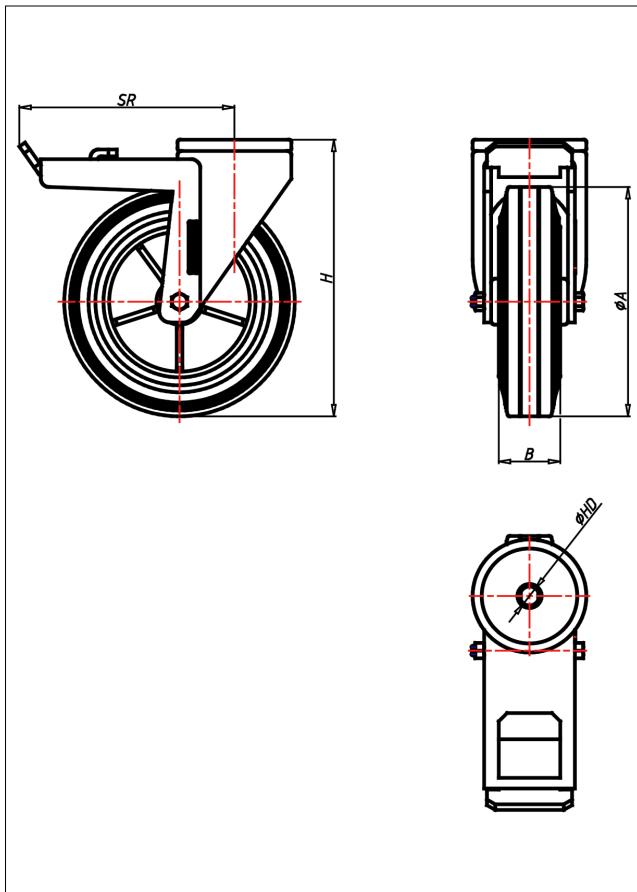

CRT-DB/D

Lenkrolle mit Totalfeststeller

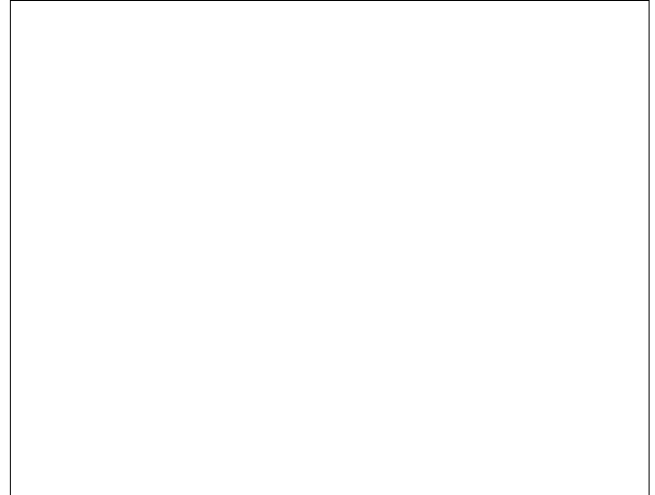

CR-D



LENKROLLE	LENKROLLE MIT TOTALFESTSTELLER	
<ul style="list-style-type: none"> geräuscharmer Lauf großer Fahrkomfort beständig gegen verdünnte Säuren Vollgummi schwarz Felge Kunststoff schwarz → Seite 255	<ul style="list-style-type: none"> zweifaches Kugellager - vernietet Stahlkugeln gehärtet Radachse verschraubt, verzinkt → Seite 62	AUSWAHLHILFE: <ul style="list-style-type: none"> leicht lenkend <input checked="" type="checkbox"/> verschleißarm <input checked="" type="checkbox"/> stoßfest <input checked="" type="checkbox"/> bodenschonend <input checked="" type="checkbox"/> witterungsbeständig <input checked="" type="checkbox"/>

Technische Details

ORDERNO (Artikel-nummer)	CRT 200 D
WDAB (Rad-Ø A x Breite B / mm)	200x50
LC (Tragkraft / kg)	205
H (Bauhöhe H / mm)	240
HD (Loch-Ø / mm)	12.5
SR (Schwenkradius / mm)	168
WB (Radlager)	Nylon-Gleitlager