

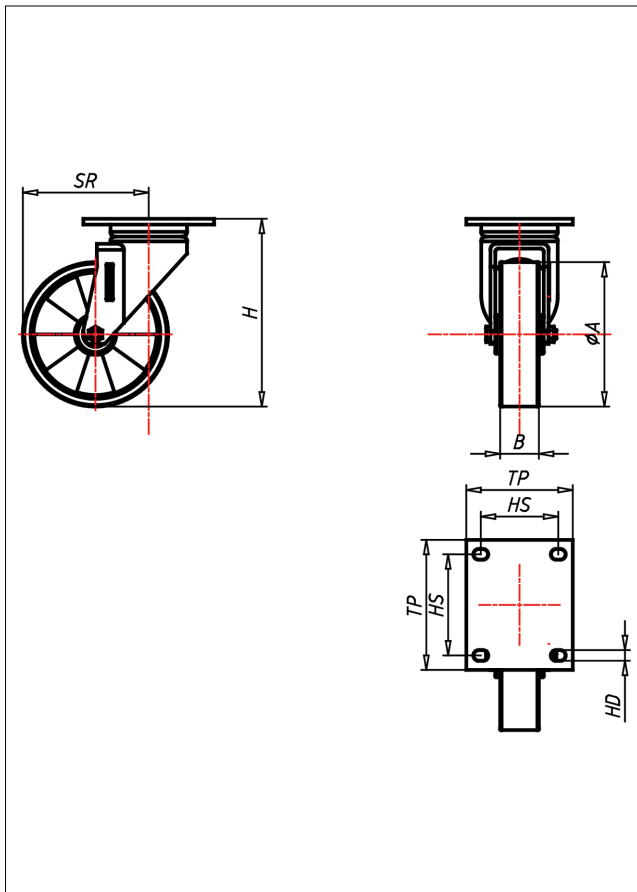

# ED-TL Lenkrolle

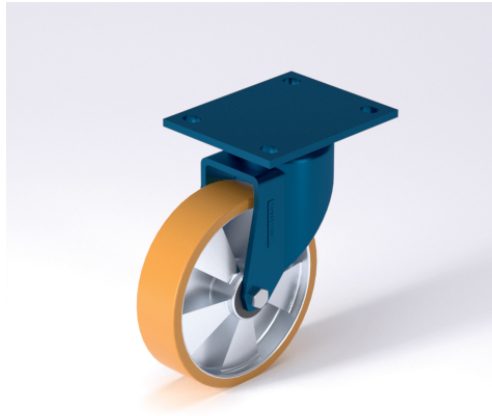

## ED-TL



**NEU!**

**Lenkrolle**  
Swivel Castor

- geräuscharmer Lauf
- geringer Rollwiderstand
- abrieb- und weiltrost
- hohe Stoßfestigkeit
- sehr beständig gegen viele aggressive Medien

Guss-Polyurethan  
Felge Spritzguss-Aluminium-Legierung  
→ Seite/Page 330

**Lenkrolle mit Totfeststeller**  
Swivel Castor with total lock

Schrägrollen- und Axialkugellager, staubgeschützt, sehr starker Zentralbolzen, Mutter gesichert, Schmierlippe  
Ausführung – lackiert

→ Seite/Page 62

**Bockrolle**  
Fixed Castor

**Auswahlhilfe**  
Selection Criteria

leicht lenkbar/swivels easily	<input type="radio"/>	<input type="radio"/>	<input type="radio"/>	<input type="radio"/>	<input type="radio"/>	<input type="radio"/>	<input type="radio"/>	<input type="radio"/>	<input type="radio"/>
verschleißarm/wear resistant	<input type="radio"/>	<input type="radio"/>	<input type="radio"/>	<input type="radio"/>	<input type="radio"/>	<input type="radio"/>	<input type="radio"/>	<input type="radio"/>	<input type="radio"/>
stoßfest/shock proof	<input type="radio"/>	<input type="radio"/>	<input type="radio"/>	<input type="radio"/>	<input type="radio"/>	<input type="radio"/>	<input type="radio"/>	<input type="radio"/>	<input type="radio"/>
bodenschonend/floor protective	<input type="radio"/>	<input type="radio"/>	<input type="radio"/>	<input type="radio"/>	<input type="radio"/>	<input type="radio"/>	<input type="radio"/>	<input type="radio"/>	<input type="radio"/>
witterungsbeständig/weather proof	<input type="radio"/>	<input type="radio"/>	<input type="radio"/>	<input type="radio"/>	<input type="radio"/>	<input type="radio"/>	<input type="radio"/>	<input type="radio"/>	<input type="radio"/>

### Technische Details

<b>ORDERNO (Artikel-nummer)</b>	ED 101 TLK
<b>WDAB (Rad-Ø A x Breite B / mm)</b>	100x40
<b>LC (Tragkraft / kg)</b>	280
<b>H (Bauhöhe H / mm)</b>	145
<b>TP (Plattengröße / mm)</b>	105x85
<b>HS (Lochabstand / mm)</b>	80x60
<b>HD (Loch-Ø / mm)</b>	9
<b>SR (Schwenkradius / mm)</b>	90
<b>WB (Radlager)</b>	Kugellager