

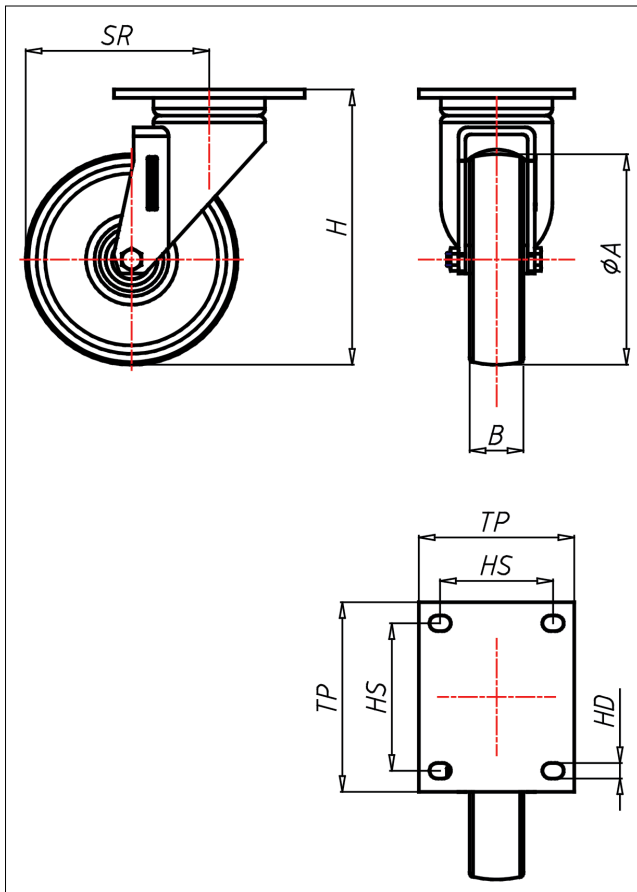

# ED-QK/Q

## Lenkrolle



### ED-Q



LENKROLLE	Feststeller TLCH Seite 42	BOCKROLLE
<ul style="list-style-type: none"> <li>• leichter Lauf auf glatten Böden</li> <li>• sehr hohe Tragkraft</li> <li>• sehr abriebfest</li> </ul> <p>Gusseisen überdreht, lackiert</p> <p>→ Seite 270</p>	<p>Schrägrollen- und Axialkugellager, staubgeschützt, sehr starker Zentralbolzen, Mütter gesichert, Schmiemoppel Ausführung – lackiert</p> <p>→ Seite 26</p>	<p>AUSWAHLHILFE: - + ++</p> <p>leicht lenkend <input type="checkbox"/> <input checked="" type="checkbox"/> <input checked="" type="checkbox"/></p> <p>verschleißarm <input type="checkbox"/> <input type="checkbox"/> <input checked="" type="checkbox"/></p> <p>stoßfest <input type="checkbox"/> <input type="checkbox"/> <input checked="" type="checkbox"/></p> <p>bodenschonend <input checked="" type="checkbox"/> <input type="checkbox"/> <input type="checkbox"/></p> <p>witterungsbeständig <input type="checkbox"/> <input type="checkbox"/> <input checked="" type="checkbox"/></p>

### Technische Details

<b>ORDERNO (Artikel-nummer)</b>	ED 150 QK
<b>WDAB (Rad-Ø A x Breite B / mm)</b>	150x38
<b>LC (Tragkraft / kg)</b>	500
<b>H (Bauhöhe H / mm)</b>	196
<b>TP (Plattengröße / mm)</b>	135x110
<b>HS (Lochabstand / mm)</b>	105x80
<b>HD (Loch-Ø / mm)</b>	11
<b>SR (Schwenkradius / mm)</b>	130
<b>WB (Radlager)</b>	Kugellager