

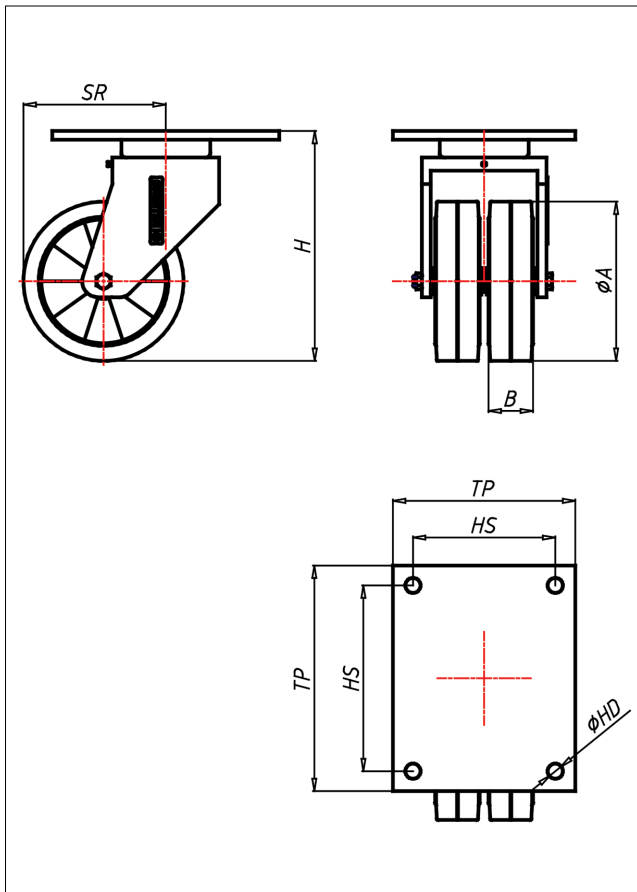

# EDD-EEK/LEEK

## Lenkrolle



### EDD-E



LENKROLLE	Festssteller TLCH Seite 42	BOCKROLLE																									
<ul style="list-style-type: none"> <li>• hoher Fahrkomfort</li> <li>• sehr laufruhig</li> <li>• geringer Rollwiderstand</li> <li>• abriebfest</li> <li>• spurfrei in grau</li> </ul>	<p>Schrägrollen- und Axialkugellager, staubgeschützt, sehr starker Zentralbolzen, Mutter gesichert, Schmiemoppel Ausführung – lackiert → Seite 26</p>	<p>AUSWAHLHILFE:</p> <table border="0"> <tr> <td>leicht lenkend</td> <td><input type="radio"/></td> <td><input type="radio"/></td> <td><input type="radio"/></td> <td><input type="radio"/></td> </tr> <tr> <td>verschleißarm</td> <td><input type="radio"/></td> <td><input checked="" type="radio"/></td> <td><input type="radio"/></td> <td><input type="radio"/></td> </tr> <tr> <td>stoßfest</td> <td><input type="radio"/></td> <td><input checked="" type="radio"/></td> <td><input type="radio"/></td> <td><input type="radio"/></td> </tr> <tr> <td>bodenschonend</td> <td><input type="radio"/></td> <td><input checked="" type="radio"/></td> <td><input type="radio"/></td> <td><input type="radio"/></td> </tr> <tr> <td>witterungsbeständig</td> <td><input type="radio"/></td> <td><input checked="" type="radio"/></td> <td><input type="radio"/></td> <td><input type="radio"/></td> </tr> </table>	leicht lenkend	<input type="radio"/>	<input type="radio"/>	<input type="radio"/>	<input type="radio"/>	verschleißarm	<input type="radio"/>	<input checked="" type="radio"/>	<input type="radio"/>	<input type="radio"/>	stoßfest	<input type="radio"/>	<input checked="" type="radio"/>	<input type="radio"/>	<input type="radio"/>	bodenschonend	<input type="radio"/>	<input checked="" type="radio"/>	<input type="radio"/>	<input type="radio"/>	witterungsbeständig	<input type="radio"/>	<input checked="" type="radio"/>	<input type="radio"/>	<input type="radio"/>
leicht lenkend	<input type="radio"/>	<input type="radio"/>	<input type="radio"/>	<input type="radio"/>																							
verschleißarm	<input type="radio"/>	<input checked="" type="radio"/>	<input type="radio"/>	<input type="radio"/>																							
stoßfest	<input type="radio"/>	<input checked="" type="radio"/>	<input type="radio"/>	<input type="radio"/>																							
bodenschonend	<input type="radio"/>	<input checked="" type="radio"/>	<input type="radio"/>	<input type="radio"/>																							
witterungsbeständig	<input type="radio"/>	<input checked="" type="radio"/>	<input type="radio"/>	<input type="radio"/>																							
<p>ELASTIK-Vollgummi Felge Spritzguss- Aluminiumlegierung → Seite 259</p>																											

### Technische Details

<b>ORDERNO (Artikel-nummer)</b>	EDD 180 EEK
<b>WDAB (Rad-Ø A x Breite B / mm)</b>	180x50+50
<b>LC (Tragkraft / kg)</b>	700
<b>H (Bauhöhe H / mm)</b>	260
<b>TP (Plattengröße / mm)</b>	255x205
<b>HS (Lochabstand / mm)</b>	210x160
<b>HD (Loch-Ø / mm)</b>	17
<b>SR (Schwenkradius / mm)</b>	160
<b>WB (Radlager)</b>	Kugellager