

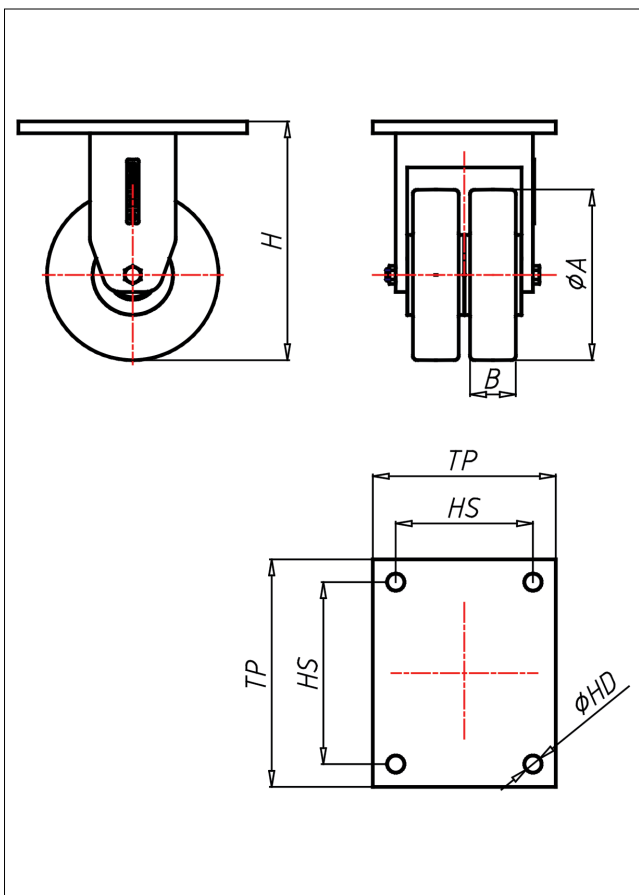

EDDF-PEK/PPEK

Bockrolle



EDD-PE



LENKROLLE	Feststeller TLCH Seite 42	BOCKROLLE																									
<ul style="list-style-type: none"> für extra schwere Lasten leichter Lauf auf glatten Böden stoß- und schlagfest hohe Abriebfestigkeit sehr beständig gegen viele aggressive Medien 	<p>Schrägrollen- und Axialkugellager, staubgeschützt, sehr starker Zentralbolzen, Mutter gesichert, Schmierlippe Ausführung – lackiert</p> <p>→ Seite 26</p>	<p>AUSWAHLHILFE:</p> <table border="0"> <tr> <td>leicht lenkend</td> <td><input type="radio"/></td> <td><input checked="" type="radio"/></td> <td><input type="radio"/></td> <td><input type="radio"/></td> </tr> <tr> <td>verschleißarm</td> <td><input type="radio"/></td> <td><input checked="" type="radio"/></td> <td><input type="radio"/></td> <td><input type="radio"/></td> </tr> <tr> <td>stoßfest</td> <td><input type="radio"/></td> <td><input checked="" type="radio"/></td> <td><input type="radio"/></td> <td><input type="radio"/></td> </tr> <tr> <td>bodenschonend</td> <td><input type="radio"/></td> <td><input checked="" type="radio"/></td> <td><input type="radio"/></td> <td><input type="radio"/></td> </tr> <tr> <td>witterungsbeständig</td> <td><input type="radio"/></td> <td><input checked="" type="radio"/></td> <td><input type="radio"/></td> <td><input type="radio"/></td> </tr> </table>	leicht lenkend	<input type="radio"/>	<input checked="" type="radio"/>	<input type="radio"/>	<input type="radio"/>	verschleißarm	<input type="radio"/>	<input checked="" type="radio"/>	<input type="radio"/>	<input type="radio"/>	stoßfest	<input type="radio"/>	<input checked="" type="radio"/>	<input type="radio"/>	<input type="radio"/>	bodenschonend	<input type="radio"/>	<input checked="" type="radio"/>	<input type="radio"/>	<input type="radio"/>	witterungsbeständig	<input type="radio"/>	<input checked="" type="radio"/>	<input type="radio"/>	<input type="radio"/>
leicht lenkend	<input type="radio"/>	<input checked="" type="radio"/>	<input type="radio"/>	<input type="radio"/>																							
verschleißarm	<input type="radio"/>	<input checked="" type="radio"/>	<input type="radio"/>	<input type="radio"/>																							
stoßfest	<input type="radio"/>	<input checked="" type="radio"/>	<input type="radio"/>	<input type="radio"/>																							
bodenschonend	<input type="radio"/>	<input checked="" type="radio"/>	<input type="radio"/>	<input type="radio"/>																							
witterungsbeständig	<input type="radio"/>	<input checked="" type="radio"/>	<input type="radio"/>	<input type="radio"/>																							
Guss-Polyamid 6 - 1. Wahl → Seite 271																											

Technische Details

ORDERNO (Artikel-nummer)	EDDF 100 PPEK
WDAB (Rad-Ø A x Breite B / mm)	100x40+40
LC (Tragkraft / kg)	1000
H (Bauhöhe H / mm)	147
TP (Plattengröße / mm)	135x110
HS (Lochabstand / mm)	105x85
HD (Loch-Ø / mm)	13
WB (Radlager)	Kugellager