

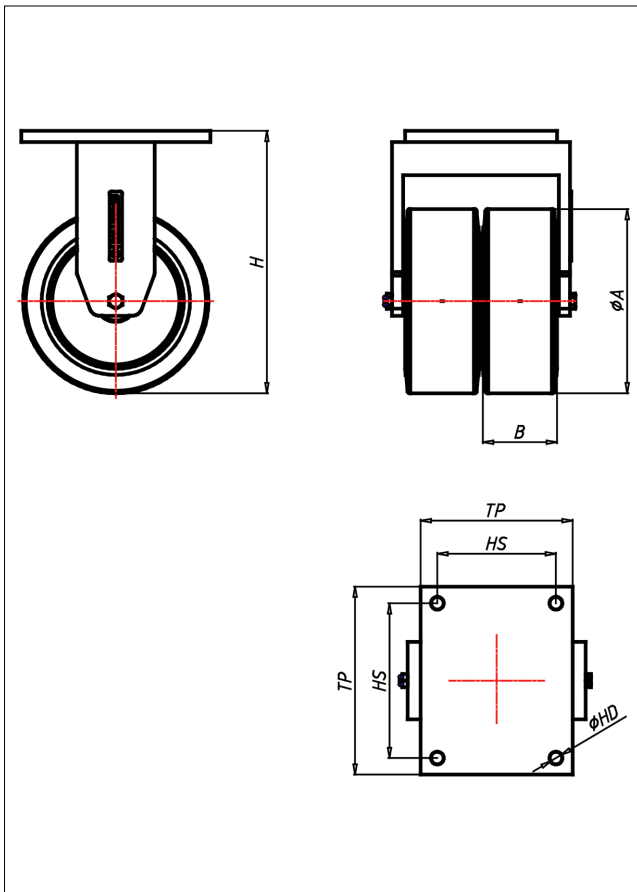

EDDF-ESK/EESK

Bockrolle

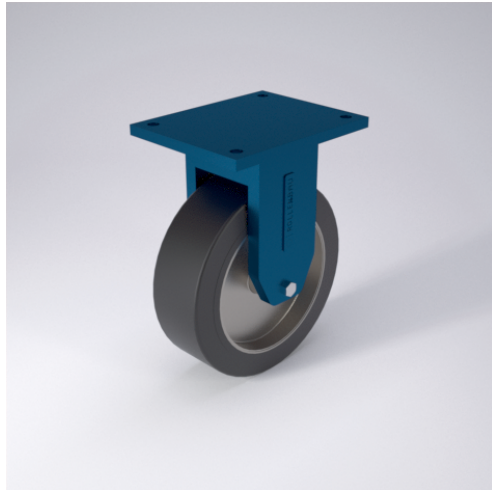

EDD-ES



LENKROLLE	Feststeller TLCH Seite 42	BOCKROLLE
<ul style="list-style-type: none"> • hoher Fahrkomfort • geringer Rollwiderstand • sehr lauffähig • sehr abriebfest • hohe Tragkraft 	<p>Schrägrollen- und Axialkugellager, staubgeschützt, sehr starker Zentralbolzen, Mutter gesichert, Schmiempfel Ausführung – lackiert → Seite 26</p>	<p>AUSWAHLHILFE:</p> <ul style="list-style-type: none"> leicht lenkend verschleißarm stoßfest bodenschonend witterungsbeständig
<p>ELASTIK-Vollgummi Felge Stahlblech verzinkt → Seite 257</p>		

Technische Details

ORDERNO (Artikel-nummer)	EDDF 300 ESK
WDAB (Rad-Ø A x Breite B / mm)	300x100
LC (Tragkraft / kg)	1600
H (Bauhöhe H / mm)	380
TP (Plattengröße / mm)	255x205
HS (Lochabstand / mm)	210x160
HD (Loch-Ø / mm)	17
WB (Radlager)	Kugellager