

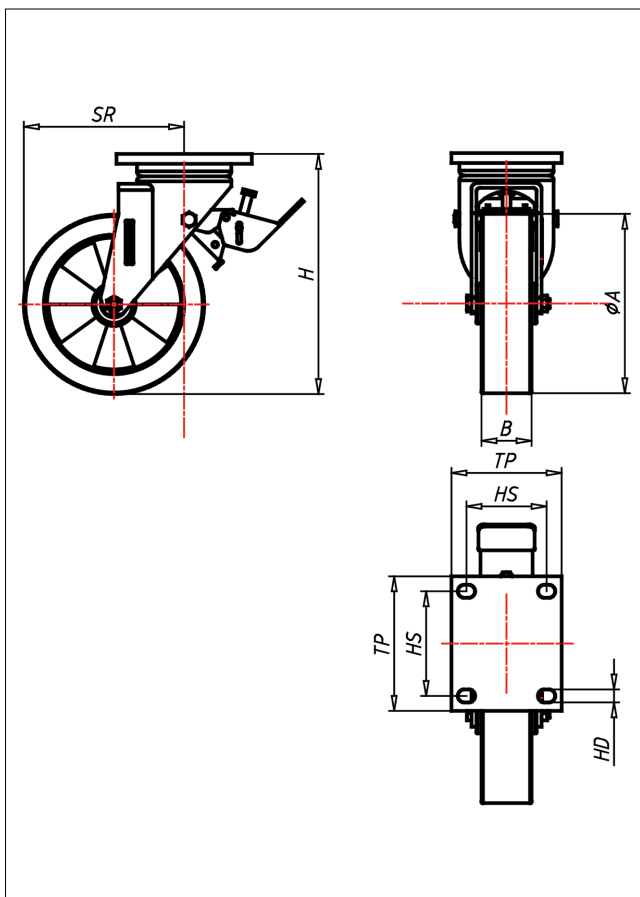

# EDT-TL

## Lenkrolle mit Totalfeststeller

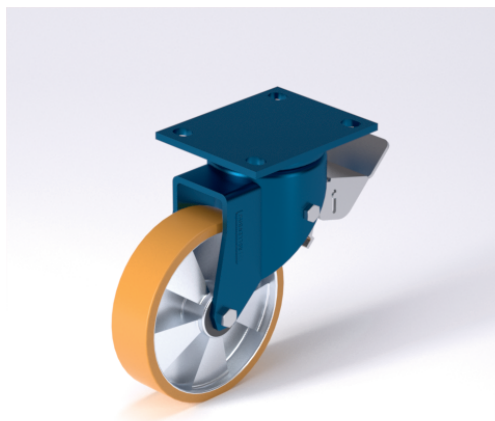

### ED-TL



**NEU!**

Lenkrolle Swivel Castor	Lenkrolle mit Totalfeststeller Swivel Castor with total lock	Bockrolle Fixed Castor
<ul style="list-style-type: none"> <li>geräuscharmer Lauf</li> <li>geringer Rollwiderstand</li> <li>abrieb- und weiltrost</li> <li>hohe Stoßfestigkeit</li> <li>sehr beständig gegen viele aggressive Medien</li> </ul>	<ul style="list-style-type: none"> <li>Schräglager- und Axialkugellager, staubgeschützt, sehr starker Zentralbolzen, Mutter gesichert, Schmierlippe</li> <li>Ausführung – lackiert</li> </ul>	<ul style="list-style-type: none"> <li>Auswahlhilfe Selection Criteria</li> <li>leicht lenkbar/steers easily</li> <li>verschleißarm/wear resistant</li> <li>stoßfest/shock proof</li> <li>bodenschonend/floor protective</li> <li>witterungsbeständig/weather proof</li> </ul>
<ul style="list-style-type: none"> <li>Guss-Polyurethan</li> <li>Felge Spritzguss-Aluminium-Legierung</li> <li>→ Seite/Page 330</li> </ul>	→ Seite/Page 62	

### Technische Details

ORDERNO (Artikel-nummer)	EDT 180 TLK
WDAB (Rad-Ø A x Breite B / mm)	180x50
LC (Tragkraft / kg)	700
H (Bauhöhe H / mm)	241
TP (Plattengröße / mm)	135x110
HS (Lochabstand / mm)	105x80
HD (Loch-Ø / mm)	13
SR (Schwenkradius / mm)	170
WB (Radlager)	Kugellager
WHEEL ( )	180 TLB 20
VER ( )	2
VERB ( )	9