

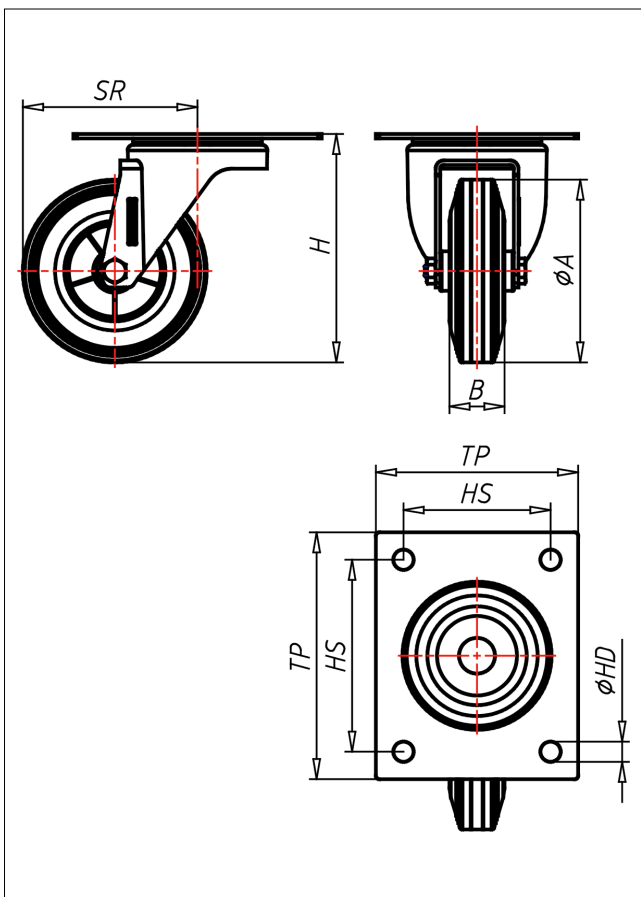

# IN/INV-DGBX/DG

## Lenkrolle



### IN-DG



LENKROLLE	LENKROLLE MIT TOTALFESTSTELLER	BOCKROLLE																		
 <ul style="list-style-type: none"> <li>• spurfrei - bodenschonend</li> <li>• hoher Fahrkomfort</li> <li>• sehr lauffähig</li> <li>• geringer Rollwiderstand</li> <li>• abriebfest</li> </ul> <p>ELASTIK-Vollgummi Felge Kunststoff → Seite 202</p> 	 <p>zweifaches Kugellager - verschraubt, Staubschützring, Radachse verschraubt - gesichert, Edelstahl poliert</p> <p>→ Seite 110</p>	 <p>AUSWAHLHILFE:</p> <table border="0"> <tr> <td>-</td><td>+</td><td>++</td> </tr> <tr> <td>leicht lenkend</td><td>X</td><td></td> </tr> <tr> <td>verschleißarm</td><td></td><td>X</td> </tr> <tr> <td>stoßfest</td><td>X</td><td></td> </tr> <tr> <td>bodenschonend</td><td></td><td>X</td> </tr> <tr> <td>witterungsbeständig</td><td></td><td>X</td> </tr> </table>	-	+	++	leicht lenkend	X		verschleißarm		X	stoßfest	X		bodenschonend		X	witterungsbeständig		X
-	+	++																		
leicht lenkend	X																			
verschleißarm		X																		
stoßfest	X																			
bodenschonend		X																		
witterungsbeständig		X																		

### Technische Details

ORDERNO (Artikel-nummer)	IN 150 DG
WDAB (Rad-Ø A x Breite B / mm)	150x40
LC (Tragkraft / kg)	150
H (Bauhöhe H / mm)	180
TP (Plattengröße / mm)	135x110
HS (Lochabstand / mm)	105x80
HD (Loch-Ø / mm)	11
SR (Schwenkradius / mm)	125
WB (Radlager)	Polyamid-Gleitlager