

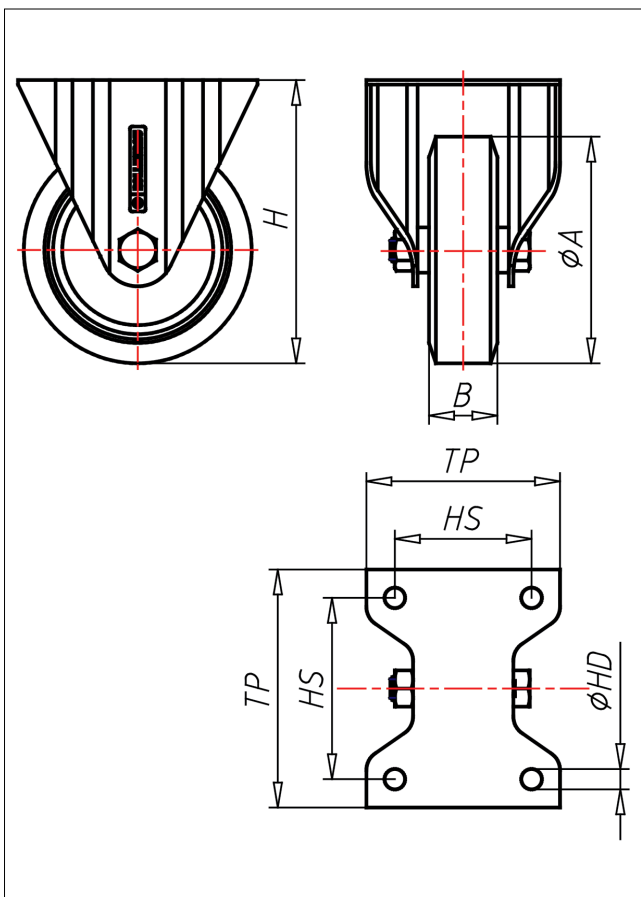

INF/INVF-A/ABX

Bockrolle



IN-A



LENKROLLE	LENKROLLE MIT TOTALFESTSTELLER	BOCKROLLE																		
<ul style="list-style-type: none"> • geräuscharmer Lauf • geringer Rollwiderstand • abrieb- und reißfest • hohe Stoßfestigkeit • leichte Reinigung • sehr beständig gegen viele aggressive Medien <p>Guss-Polyurethan Felge Polyamid 6 → Seite 252</p>	<p>zweifaches Kugellager - verschraubt, Staubschützing, Radachse verschraubt - gesichert, Edelstahl poliert</p> <p>→ Seite 110</p>	<p>AUSWAHLHILFE:</p> <table border="0"> <tr> <td>-</td> <td>+</td> <td>++</td> </tr> <tr> <td>leicht lenkend</td> <td>X</td> <td></td> </tr> <tr> <td>verschleißarm</td> <td></td> <td>X</td> </tr> <tr> <td>stoßfest</td> <td>X</td> <td></td> </tr> <tr> <td>bodenschonend</td> <td></td> <td>X</td> </tr> <tr> <td>witterungsbeständig</td> <td></td> <td>X</td> </tr> </table>	-	+	++	leicht lenkend	X		verschleißarm		X	stoßfest	X		bodenschonend		X	witterungsbeständig		X
-	+	++																		
leicht lenkend	X																			
verschleißarm		X																		
stoßfest	X																			
bodenschonend		X																		
witterungsbeständig		X																		

Technische Details

ORDERNO (Artikel-nummer)	INF 100 ABX
WDAB (Rad-Ø A x Breite B / mm)	100x30
LC (Tragkraft / kg)	125
H (Bauhöhe H / mm)	125
TP (Plattengröße / mm)	105x85
HS (Lochabstand / mm)	80x60
HD (Loch-Ø / mm)	9
WB (Radlager)	Rollenlager