

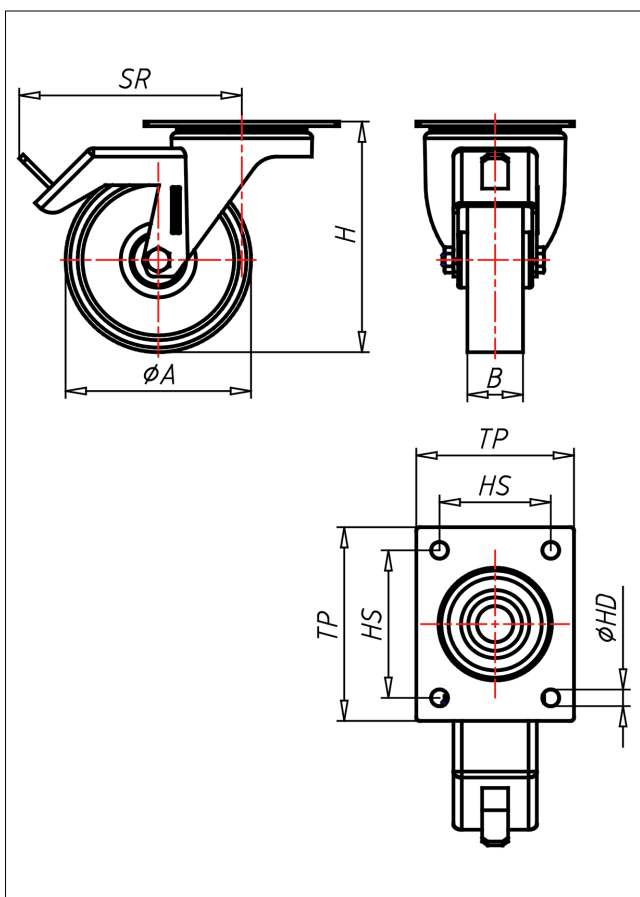

INT/INVT-ALBX/AL

Lenkrolle mit Totalfeststeller



IN-AL



LENKROLLE	LENKROLLE MIT TOTALFESTSTELLER	BOCKROLLE																		
 <ul style="list-style-type: none"> • geringer Rollwiderstand • abrieb- und reißfest • leichte Reinigung • sehr beständig gegen viele aggressive Medien <p>Spritzguss-Polyurethan Felge Polyamid 6 → Seite 233</p> 	 <p>zweifaches Kugellager - verschraubt, Staubschützring, Radachse verschraubt - gesichert, Edelstahl poliert</p> <p>→ Seite 110</p>	 <p>AUSWAHLHILFE:</p> <table border="0"> <tr> <td>-</td> <td>+</td> <td>++</td> </tr> <tr> <td>leicht lenkend</td> <td>X</td> <td></td> </tr> <tr> <td>verschleißarm</td> <td></td> <td>X</td> </tr> <tr> <td>stoßfest</td> <td>X</td> <td></td> </tr> <tr> <td>bodenschonend</td> <td>X</td> <td></td> </tr> <tr> <td>witterungsbeständig</td> <td></td> <td>X</td> </tr> </table>	-	+	++	leicht lenkend	X		verschleißarm		X	stoßfest	X		bodenschonend	X		witterungsbeständig		X
-	+	++																		
leicht lenkend	X																			
verschleißarm		X																		
stoßfest	X																			
bodenschonend	X																			
witterungsbeständig		X																		

Technische Details

ORDERNO (Artikel-nummer)	INT 200 AL
WDAB (Rad-Ø A x Breite B / mm)	200x50
LC (Tragkraft / kg)	250
H (Bauhöhe H / mm)	230
TP (Plattengröße / mm)	135x110
HS (Lochabstand / mm)	105x80
HD (Loch-Ø / mm)	11
SR (Schwenkradius / mm)	190
WB (Radlager)	Polyamid-Gleitlager