

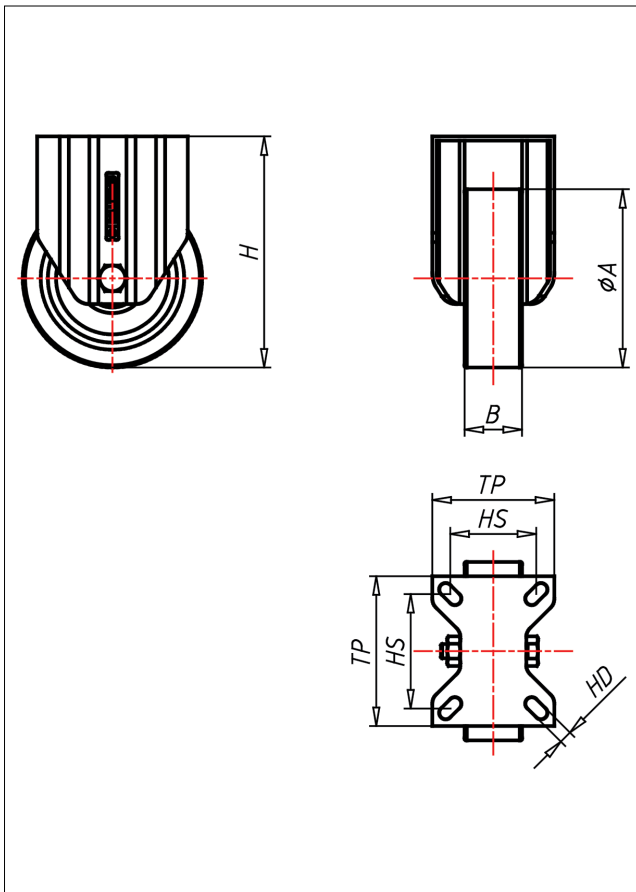

IPF/IPSF-PSKX

Bockrolle

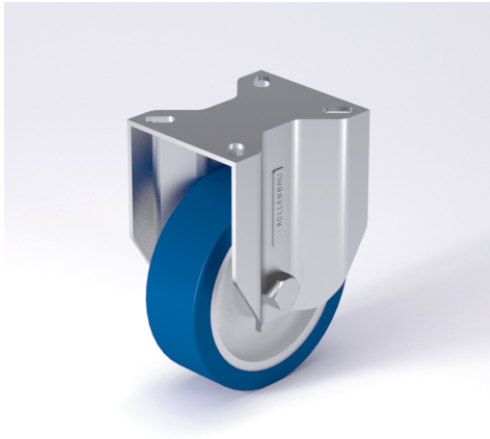

IP-PS

+80 °C
-30 °C
max. 600 kg



IP-PS	Lenkrolle Swivel Castor	Lenkrolle mit Totalfeststeller Swivel Castor with total lock	Bockrolle Fixed Castor																			
NEU!																						
<ul style="list-style-type: none"> sehr laufruhig geringer Rollwiderstand abrieb- und weildfest hohe Stofffestigkeit leichte Reinigung sehr beständig gegen viele aggressive Medien Polyurethan 87±3 Shore A weich Felle Polyamid 6 → Seite/Page 338	Gehäuse aus Edelstahl AISI 304, eingeleiteter Zentralzapfen aus Edelstahl AISI 304, verschraubt, Wasser- und Staubabdichtungsring → Seite/Page 184	Auswahlhilfe Selection Criteria <table border="1"> <tr> <td>leicht lenkbar/swivels easily</td> <td><input type="checkbox"/></td> <td><input checked="" type="checkbox"/></td> <td><input checked="" type="checkbox"/></td> </tr> <tr> <td>verschleißarm/wear resistant</td> <td><input type="checkbox"/></td> <td><input checked="" type="checkbox"/></td> <td><input checked="" type="checkbox"/></td> </tr> <tr> <td>staubfest/dust proof</td> <td><input type="checkbox"/></td> <td><input checked="" type="checkbox"/></td> <td><input checked="" type="checkbox"/></td> </tr> <tr> <td>bodenschonend/floor protection</td> <td><input type="checkbox"/></td> <td><input checked="" type="checkbox"/></td> <td><input checked="" type="checkbox"/></td> </tr> <tr> <td>witterungsbeständig/weather proof</td> <td><input type="checkbox"/></td> <td><input checked="" type="checkbox"/></td> <td><input checked="" type="checkbox"/></td> </tr> </table>	leicht lenkbar/swivels easily	<input type="checkbox"/>	<input checked="" type="checkbox"/>	<input checked="" type="checkbox"/>	verschleißarm/wear resistant	<input type="checkbox"/>	<input checked="" type="checkbox"/>	<input checked="" type="checkbox"/>	staubfest/dust proof	<input type="checkbox"/>	<input checked="" type="checkbox"/>	<input checked="" type="checkbox"/>	bodenschonend/floor protection	<input type="checkbox"/>	<input checked="" type="checkbox"/>	<input checked="" type="checkbox"/>	witterungsbeständig/weather proof	<input type="checkbox"/>	<input checked="" type="checkbox"/>	<input checked="" type="checkbox"/>
leicht lenkbar/swivels easily	<input type="checkbox"/>	<input checked="" type="checkbox"/>	<input checked="" type="checkbox"/>																			
verschleißarm/wear resistant	<input type="checkbox"/>	<input checked="" type="checkbox"/>	<input checked="" type="checkbox"/>																			
staubfest/dust proof	<input type="checkbox"/>	<input checked="" type="checkbox"/>	<input checked="" type="checkbox"/>																			
bodenschonend/floor protection	<input type="checkbox"/>	<input checked="" type="checkbox"/>	<input checked="" type="checkbox"/>																			
witterungsbeständig/weather proof	<input type="checkbox"/>	<input checked="" type="checkbox"/>	<input checked="" type="checkbox"/>																			

Technische Details

ORDERNO (Artikel-nummer)	IPF 100 PSKX
WDAB (Rad-Ø A x Breite B / mm)	100x40
LC (Tragkraft / kg)	250
H (Bauhöhe H / mm)	137
TP (Plattengröße / mm)	105x85
HS (Lochabstand / mm)	80x60
HD (Loch-Ø / mm)	9
SR (Schwenkradius / mm)	0
WB (Radlager)	Rollenlager