

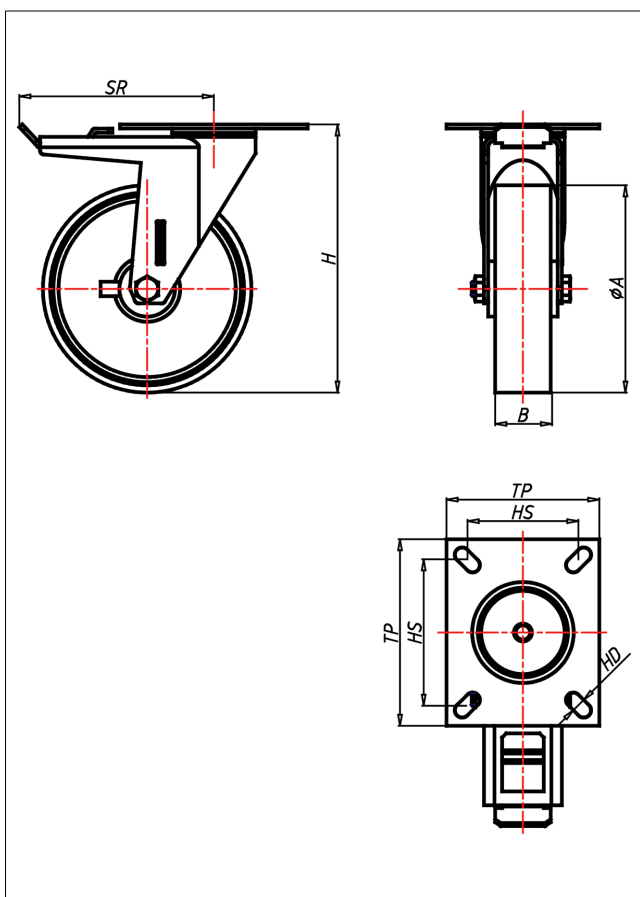

KDT/KST-PK/PB/P

Lenkrolle mit Totalfeststeller



KD-P



LENKROLLE	LENKROLLE MIT TOTALFESTSTELLER	BOCKROLLE																				
<ul style="list-style-type: none"> • leichter Lauf auf glatten Böden • stoß- und schlagfest • hohe Abriebfestigkeit • leicht zu reinigen • sehr beständig gegen viele aggressive Medien <p>Polyamid 6 - 1. Wahl → Seite 272</p>	<p>Laufkugeln gehärtet, Kugelbahnen gepresst, starker Zentralzapfen verschraubt - gedichtet - gesichert Staubschutzring, verzinkt</p> <p>→ Seite 62</p>	<p>AUSWAHLHILFE:</p> <table border="0"> <tr> <td>leicht lenkend</td> <td>+</td> <td>+</td> <td>+</td> </tr> <tr> <td>verschleißarm</td> <td>x</td> <td>x</td> <td>x</td> </tr> <tr> <td>stoßfest</td> <td>+</td> <td>+</td> <td>+</td> </tr> <tr> <td>bodenschonend</td> <td>x</td> <td>x</td> <td>x</td> </tr> <tr> <td>witterungsbeständig</td> <td>x</td> <td>x</td> <td>x</td> </tr> </table>	leicht lenkend	+	+	+	verschleißarm	x	x	x	stoßfest	+	+	+	bodenschonend	x	x	x	witterungsbeständig	x	x	x
leicht lenkend	+	+	+																			
verschleißarm	x	x	x																			
stoßfest	+	+	+																			
bodenschonend	x	x	x																			
witterungsbeständig	x	x	x																			

Technische Details

ORDERNO (Artikel-nummer)	KDT 150 PB
WDAB (Rad-Ø A x Breite B / mm)	150x40
LC (Tragkraft / kg)	300
H (Bauhöhe H / mm)	194
TP (Plattengröße / mm)	135x110
HS (Lochabstand / mm)	105x80
HD (Loch-Ø / mm)	10.5
SR (Schwenkradius / mm)	140
WB (Radlager)	Rollenlager