

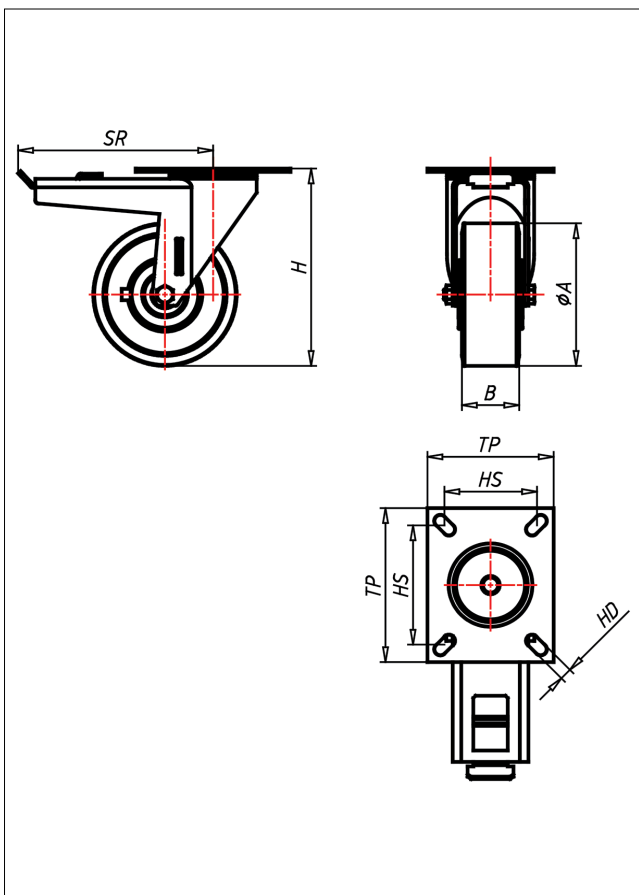

KDT-TLSK

Lenkrolle mit Totalfeststeller

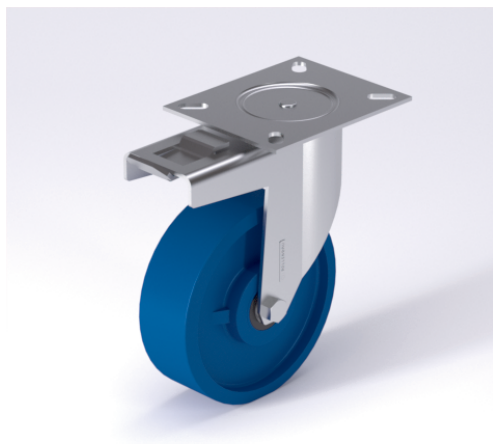

KD-TLS



NEU!

Lenkrolle Swivel Castor	Lenkrolle mit Totalfeststeller Swivel Castor with total lock	Bockrolle Fixed Castor
<ul style="list-style-type: none"> sehr laufruhig geringer Rollwiderstand abrieb- und weilläst hohe Stoßfestigkeit leichte Reinigung sehr beständig gegen viele aggressive Medien 	<ul style="list-style-type: none"> Laufkugeln gehärtet, Kugelbahnen gepresst, starker Zentralzapfen verschraubt - gedichtet - gesichert Staubschutzing, verzinkt 	<ul style="list-style-type: none"> Auswahlhilfe Selection Criteria leicht lenkbar/swivels easily verschleißarm/wear resistant staubdicht/leak proof bodenschonend/floor protection witterungsbeständig/weather proof
<ul style="list-style-type: none"> Guss-Polyurethan 70±3 Shore A weich Felge Spritzguss-Aluminium-Legierung → Seite/Page 332 	→ Seite/Page 112	

Technische Details

ORDERNO (Artikel-nummer)	KDT 200 TLSK
WDAB (Rad-Ø A x Breite B / mm)	200x50
LC (Tragkraft / kg)	450
H (Bauhöhe H / mm)	249
TP (Plattengröße / mm)	135x110
HS (Lochabstand / mm)	105x80
HD (Loch-Ø / mm)	12.5
SR (Schwenkradius / mm)	170
WB (Radlager)	Kugellager