

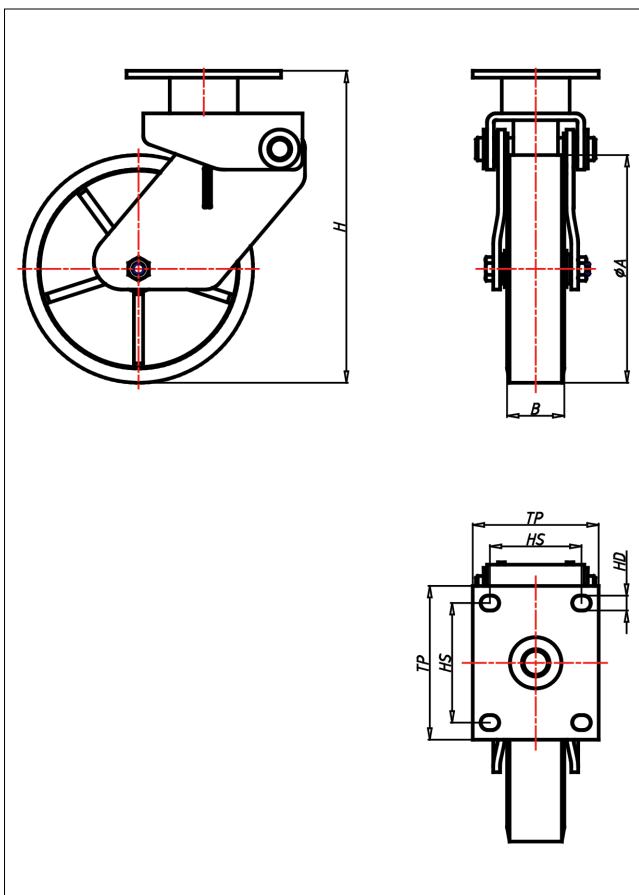

MFFA/MFFB/MFFC-ZK

Bockrolle



MFA-Z



LENKROLLE	BOCKROLLE	
<ul style="list-style-type: none"> geräuscharmer Lauf geringer Rollwiderstand abrieb- und reißfest hohe Stoßfestigkeit sehr beständig gegen viele aggressive Medien <p>Guss-Polyurethan Felge Gusseisen lackiert → Seite 245</p>	<p>zweifaches Kugellager, Polyurethan-Federelement, Schwinghebel auf Bronzebuchsen, schwarz lackiert</p> <p>→ Seite 62</p>	<p>AUSWAHLHILFE:</p> <ul style="list-style-type: none"> leicht lenkend <input checked="" type="checkbox"/> verschleißarm <input checked="" type="checkbox"/> stoßfest <input checked="" type="checkbox"/> bodenschonend <input checked="" type="checkbox"/> witterungsbeständig <input checked="" type="checkbox"/>

Technische Details

ORDERNO (Artikel-nummer)	MFFA 125 ZK
WDAB (Rad-Ø A x Breite B / mm)	125x30
LC (Tragkraft / kg)	200
PF (Vorspannkraft / daN)	90
MST (Max. Federweg / mm)	25
H (Bauhöhe H / mm)	207
TP (Plattengröße / mm)	105x85
HS (Lochabstand / mm)	80x60
HD (Loch-Ø / mm)	11
WB (Radlager)	Kugellager