

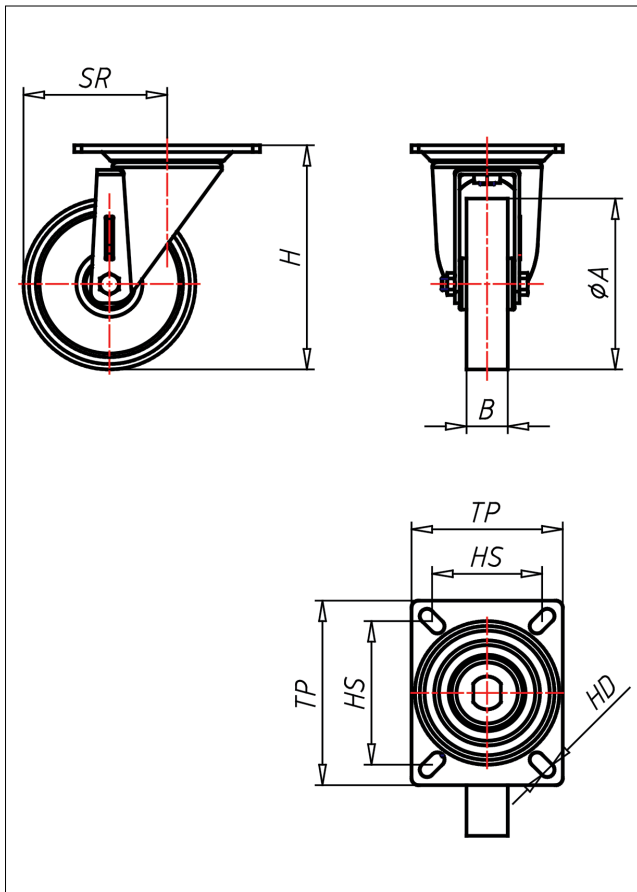

# PD-ALB/AL/ALK

## Lenkrolle

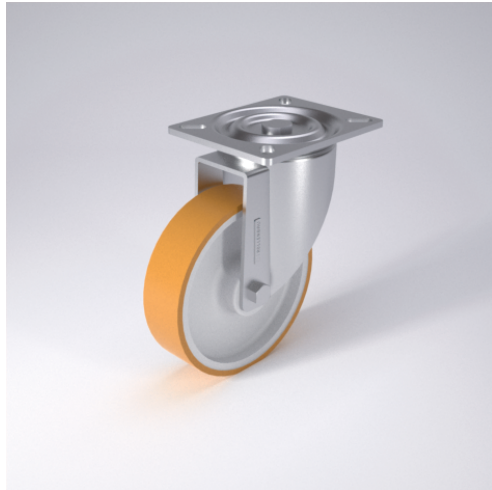

### PD-AL



LENKROLLE	LENKROLLE MIT TOTALFESTSTELLER	BOCKROLLE															
<ul style="list-style-type: none"> <li>• geringer Rollwiderstand</li> <li>• abrieb- und reißfest</li> <li>• leichte Reinigung</li> <li>• sehr beständig gegen viele aggressive Medien</li> </ul> Spritzguss-Polyurethan Felge Polyamid 6 → Seite 253	gehärtete Stahlkugeln, zweifache Kugelbahnen aus gehärtetem Stahlblech, mit starkem Zentralzapfen verschraubt und gesichert - nachstellbar → Seite 42	AUSWAHLHILFE: <table border="0"> <tr> <td>leicht lenkend</td> <td><input checked="" type="checkbox"/></td> <td><input checked="" type="checkbox"/></td> </tr> <tr> <td>verschleißarm</td> <td><input checked="" type="checkbox"/></td> <td><input checked="" type="checkbox"/></td> </tr> <tr> <td>stoßfest</td> <td><input checked="" type="checkbox"/></td> <td><input checked="" type="checkbox"/></td> </tr> <tr> <td>bodenschonend</td> <td><input checked="" type="checkbox"/></td> <td><input checked="" type="checkbox"/></td> </tr> <tr> <td>witterungsbeständig</td> <td><input checked="" type="checkbox"/></td> <td><input checked="" type="checkbox"/></td> </tr> </table>	leicht lenkend	<input checked="" type="checkbox"/>	<input checked="" type="checkbox"/>	verschleißarm	<input checked="" type="checkbox"/>	<input checked="" type="checkbox"/>	stoßfest	<input checked="" type="checkbox"/>	<input checked="" type="checkbox"/>	bodenschonend	<input checked="" type="checkbox"/>	<input checked="" type="checkbox"/>	witterungsbeständig	<input checked="" type="checkbox"/>	<input checked="" type="checkbox"/>
leicht lenkend	<input checked="" type="checkbox"/>	<input checked="" type="checkbox"/>															
verschleißarm	<input checked="" type="checkbox"/>	<input checked="" type="checkbox"/>															
stoßfest	<input checked="" type="checkbox"/>	<input checked="" type="checkbox"/>															
bodenschonend	<input checked="" type="checkbox"/>	<input checked="" type="checkbox"/>															
witterungsbeständig	<input checked="" type="checkbox"/>	<input checked="" type="checkbox"/>															

### Technische Details

<b>ORDERNO (Artikel-nummer)</b>	PD 100 AL
<b>WDAB (Rad-Ø A x Breite B / mm)</b>	100x30
<b>LC (Tragkraft / kg)</b>	160
<b>H (Bauhöhe H / mm)</b>	138
<b>TP (Plattengröße / mm)</b>	105x85
<b>HS (Lochabstand / mm)</b>	80x60
<b>HD (Loch-Ø / mm)</b>	8.5
<b>SR (Schwenkradius / mm)</b>	92
<b>WB (Radlager)</b>	Polyamid-Gleitlager