

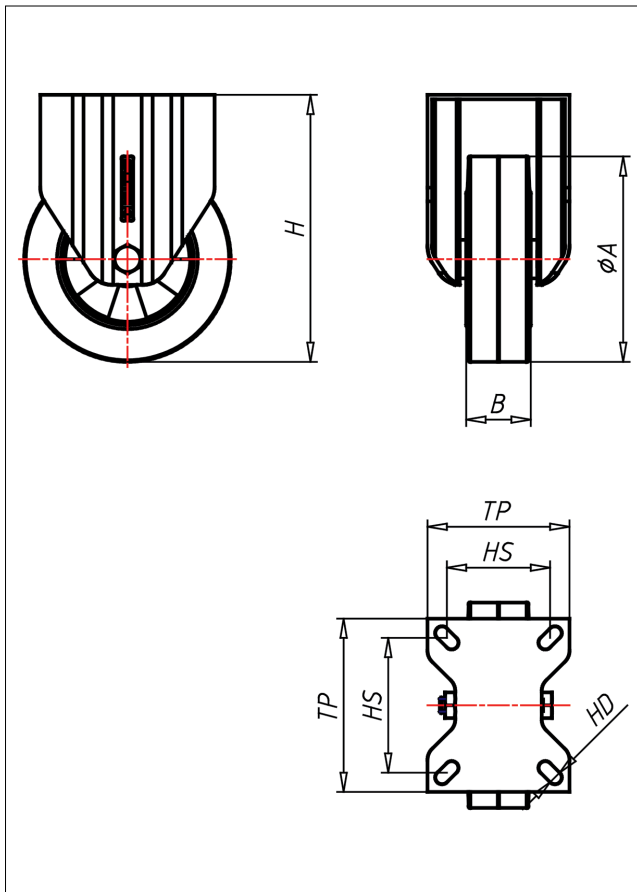

# PDF/PSF- EK/EB/LEK/LEB Bockrolle

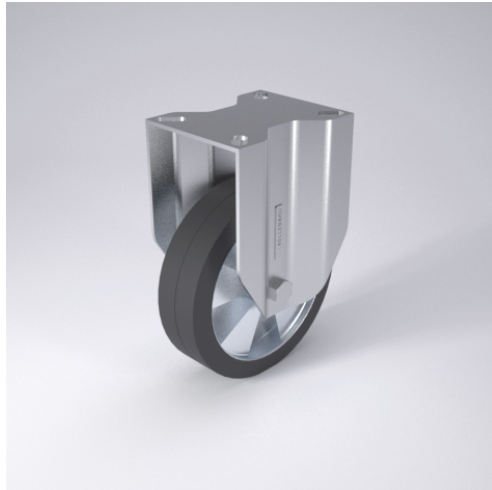

PD-E



LENKROLLE	LENKROLLE MIT TOTALFESTSTELLER	BOCKROLLE															
<ul style="list-style-type: none"> <li>• hoher Fahrkomfort</li> <li>• sehr laufruhig</li> <li>• geringer Rollwiderstand</li> <li>• abriebfest</li> <li>• spurfrei in grau</li> </ul> <p>ELASTIK-Vollgummi Felge Spritzguss-Aluminiumgehäuse → Seite 259</p>	<p>gehärtete Stahlkugeln, zweifache Kugelbahnen aus gehärtetem Stahlblech, mit starkem Zentralzapfen verschraubt und gesichert - nachstellbar</p> <p>→ Seite 42</p>	<p>AUSWAHLHILFE:</p> <table border="1"> <tr> <td>leicht lenkend</td> <td>X</td> <td>X</td> </tr> <tr> <td>verschleißarm</td> <td>X</td> <td>X</td> </tr> <tr> <td>stoßfest</td> <td>X</td> <td>X</td> </tr> <tr> <td>bodenschonend</td> <td>X</td> <td>X</td> </tr> <tr> <td>witterungsbeständig</td> <td>X</td> <td>X</td> </tr> </table>	leicht lenkend	X	X	verschleißarm	X	X	stoßfest	X	X	bodenschonend	X	X	witterungsbeständig	X	X
leicht lenkend	X	X															
verschleißarm	X	X															
stoßfest	X	X															
bodenschonend	X	X															
witterungsbeständig	X	X															

## Technische Details

<b>ORDERNO (Artikel-nummer)</b>	PDF 100 EK
<b>WDAB (Rad-Ø A x Breite B / mm)</b>	100x40
<b>LC (Tragkraft / kg)</b>	150
<b>H (Bauhöhe H / mm)</b>	139
<b>TP (Plattengröße / mm)</b>	105x85
<b>HS (Lochabstand / mm)</b>	80x60
<b>HD (Loch-Ø / mm)</b>	8.5
<b>WB (Radlager)</b>	Kugellager