

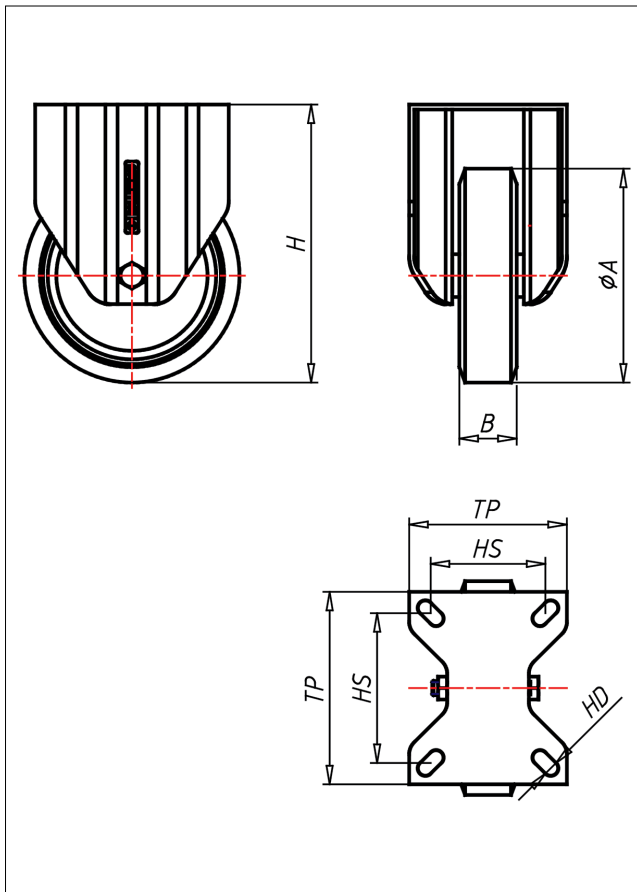

PDF-AK/AB/A

Bockrolle

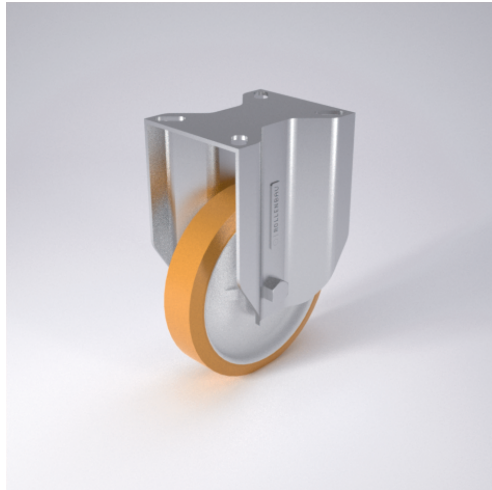

PD-A



LENKROLLE	LENKROLLE MIT TOTALFESTSTELLER	BOCKROLLE
<ul style="list-style-type: none"> geräuscharmer Lauf geringer Rollwiderstand abrieb- und reißfest hohe Stoßfestigkeit leichte Reinigung sehr beständig gegen viele aggressive Medien 	<ul style="list-style-type: none"> gehärtete Stahlkugeln, zweifache Kugelbahnen aus gehärtetem Stahlblech, mit starkem Zentralzapfen verschraubt und gesichert - nachstellbar 	<p>AUSWAHLHILFE:</p> <ul style="list-style-type: none"> leicht lenkend <input checked="" type="checkbox"/> verschleißarm <input checked="" type="checkbox"/> stoßfest <input checked="" type="checkbox"/> bodenschonend <input checked="" type="checkbox"/> witterungsbeständig <input checked="" type="checkbox"/>
<p>Guss-Polyurethan Felge Polyamid 6 → Seite 252</p>	<p>→ Seite 42</p>	

Technische Details

ORDERNO (Artikel-nummer)	PDF 200 AB
WDAB (Rad-Ø A x Breite B / mm)	200x50
LC (Tragkraft / kg)	600
H (Bauhöhe H / mm)	250
TP (Plattengröße / mm)	135x110
HS (Lochabstand / mm)	105x80
HD (Loch-Ø / mm)	12.5
WB (Radlager)	Rollenlager