

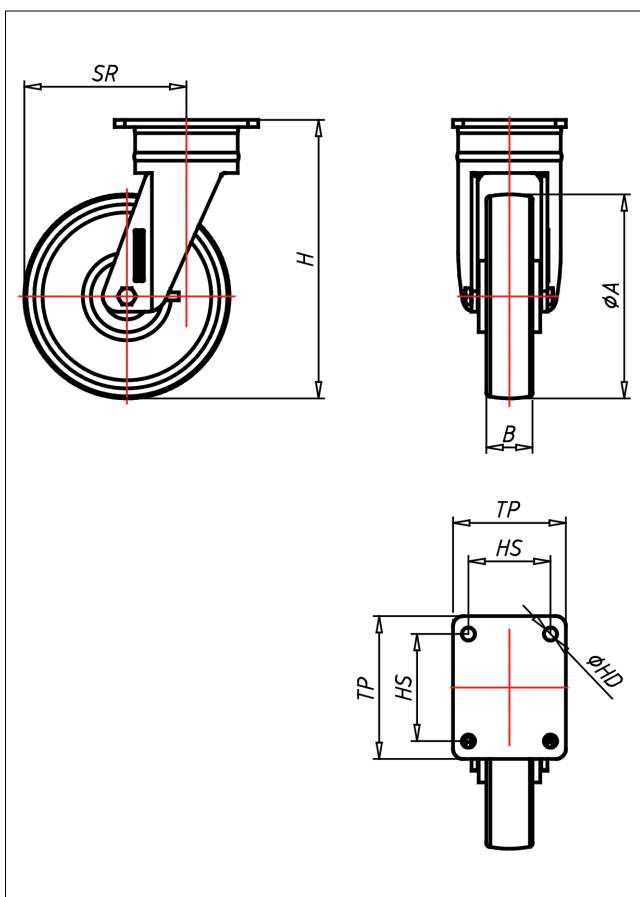

QD-QK/CIB Lenkrolle



QD-Q



LENKROLLE	LENKROLLE MIT TOTALFESTSTELLER	BOCKROLLE																				
<ul style="list-style-type: none"> • leichter Lauf auf glatten Böden • sehr hohe Tragkraft • sehr abriebfest Gusseisen überdreht, lackiert → Seite 270	 Schrägrollen- und Axialkugellager, staubgeschützt, sehr starker Zentralbolzen, Mütter gesichert, Schmiernippel Ausführung verzinkt → Seite 28	AUSWAHLHILFE: <table border="1"> <tr> <td>leicht lenkend</td> <td><input type="checkbox"/></td> <td><input checked="" type="checkbox"/></td> <td><input checked="" type="checkbox"/></td> </tr> <tr> <td>verschleißarm</td> <td><input type="checkbox"/></td> <td><input checked="" type="checkbox"/></td> <td><input checked="" type="checkbox"/></td> </tr> <tr> <td>stoßfest</td> <td><input type="checkbox"/></td> <td><input checked="" type="checkbox"/></td> <td><input checked="" type="checkbox"/></td> </tr> <tr> <td>bodenschonend</td> <td><input checked="" type="checkbox"/></td> <td><input type="checkbox"/></td> <td><input type="checkbox"/></td> </tr> <tr> <td>witterungsbeständig</td> <td><input type="checkbox"/></td> <td><input checked="" type="checkbox"/></td> <td><input checked="" type="checkbox"/></td> </tr> </table>	leicht lenkend	<input type="checkbox"/>	<input checked="" type="checkbox"/>	<input checked="" type="checkbox"/>	verschleißarm	<input type="checkbox"/>	<input checked="" type="checkbox"/>	<input checked="" type="checkbox"/>	stoßfest	<input type="checkbox"/>	<input checked="" type="checkbox"/>	<input checked="" type="checkbox"/>	bodenschonend	<input checked="" type="checkbox"/>	<input type="checkbox"/>	<input type="checkbox"/>	witterungsbeständig	<input type="checkbox"/>	<input checked="" type="checkbox"/>	<input checked="" type="checkbox"/>
leicht lenkend	<input type="checkbox"/>	<input checked="" type="checkbox"/>	<input checked="" type="checkbox"/>																			
verschleißarm	<input type="checkbox"/>	<input checked="" type="checkbox"/>	<input checked="" type="checkbox"/>																			
stoßfest	<input type="checkbox"/>	<input checked="" type="checkbox"/>	<input checked="" type="checkbox"/>																			
bodenschonend	<input checked="" type="checkbox"/>	<input type="checkbox"/>	<input type="checkbox"/>																			
witterungsbeständig	<input type="checkbox"/>	<input checked="" type="checkbox"/>	<input checked="" type="checkbox"/>																			

Technische Details

ORDERNO (Artikel-nummer)	QD 151 QK
WDAB (Rad-Ø A x Breite B / mm)	150x55
LC (Tragkraft / kg)	1200
H (Bauhöhe H / mm)	228
TP (Plattengröße / mm)	140x110
HS (Lochabstand / mm)	105x80
HD (Loch-Ø / mm)	12.5
SR (Schwenkradius / mm)	132
WB (Radlager)	Kugellager