

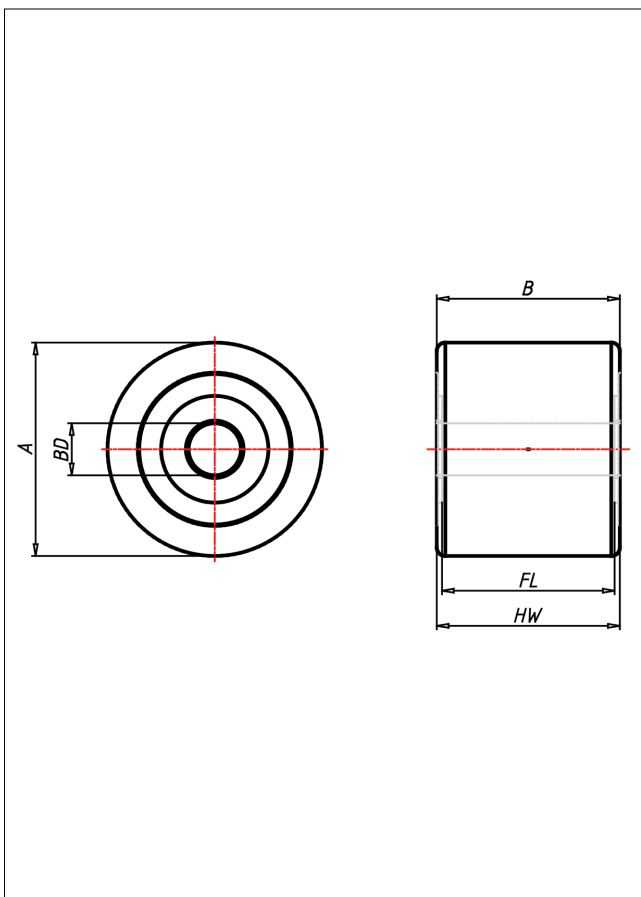

RP
Rad

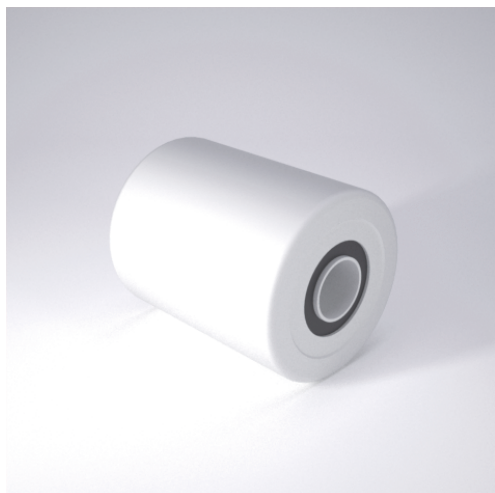

RP



Vollrad aus Polyamid 6 - 1. Wahl

- leichter Lauf auf glatten Böden
- stoß- und schlagfest
- hohe Abriebfestigkeit
- sehr beständig gegen viele aggressive Medien

Technische Details

| | |
|---------------------------------------|---------------------------------|
| ORDERNO (Artikel-nummer) | RP 82x100 K20 |
| WDAB (Rad-Ø A x Breite B / mm) | 82x100 |
| LC (Tragkraft / kg) | 1000 |
| HW (Nabellänge / mm) | 100 |
| FL (Einbaulänge / mm) | 96 |
| WB (Radlager) | 2 Rillen-Kugellager 6204 2RS |
| BD (Bohrungsdurchmesser / mm) | 20 |