

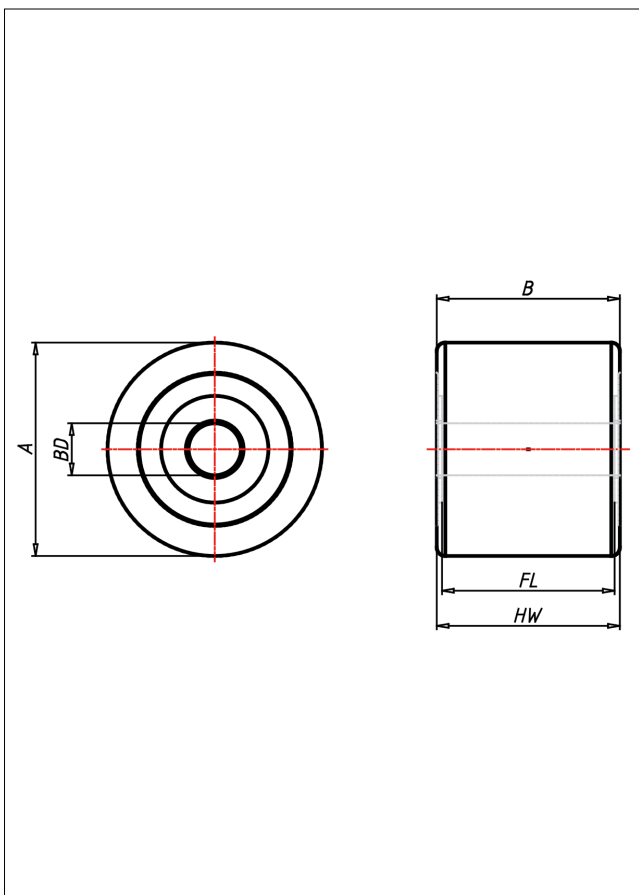

**RP**  
Rad

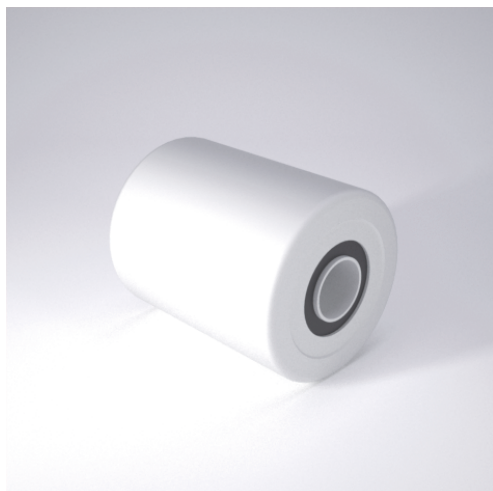

RP



Vollrad aus Polyamid 6 - 1. Wahl

- leichter Lauf auf glatten Böden
- stoß- und schlagfest
- hohe Abriebfestigkeit
- sehr beständig gegen viele aggressive Medien

### Technische Details

<b>ORDERNO (Artikel-nummer)</b>	RP 85x100 K20
<b>WDAB (Rad-Ø A x Breite B / mm)</b>	85x100
<b>LC (Tragkraft / kg)</b>	1000
<b>HW (Nabellänge / mm)</b>	100
<b>FL (Einbaulänge / mm)</b>	100
<b>WB (Radlager)</b>	2 Rillen-Kugellager 6204 2RS
<b>BD (Bohrungsdurchmesser / mm)</b>	20