

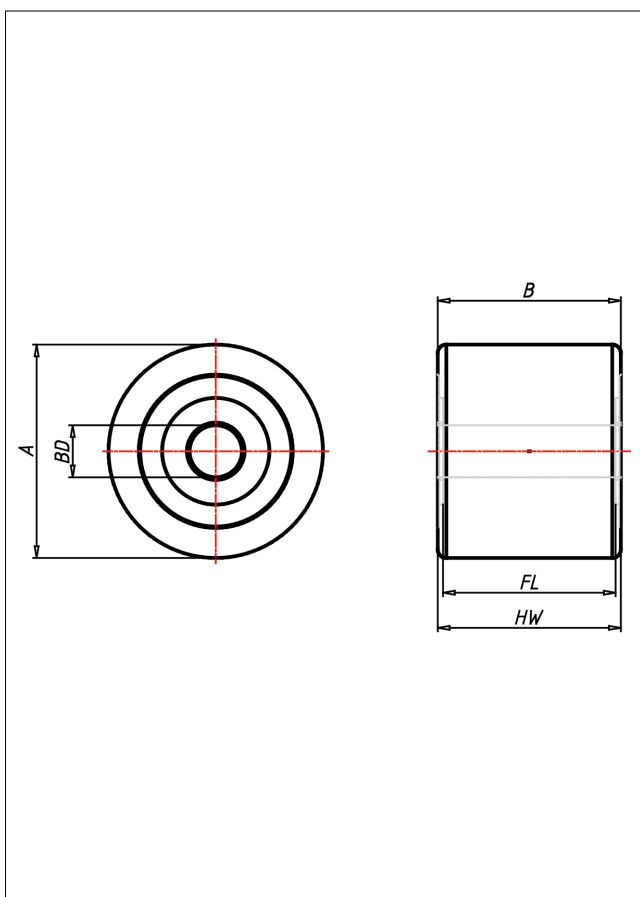

RP Rad

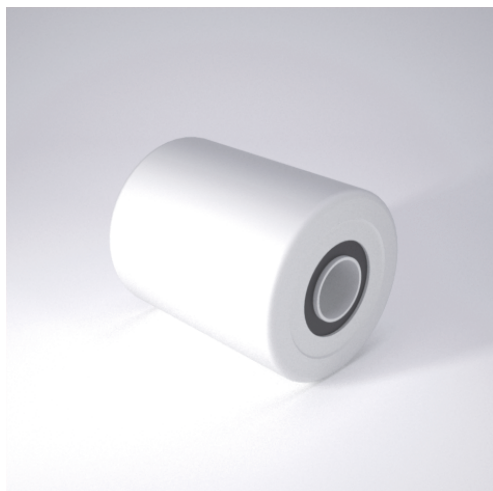

RP



Vollrad aus Polyamid 6 - 1. Wahl

- leichter Lauf auf glatten Böden
- stoß- und schlagfest
- hohe Abriebfestigkeit
- sehr beständig gegen viele aggressive Medien

Technische Details

ORDERNO (Artikel-nummer)	RP 85x60 K25
WDAB (Rad-Ø A x Breite B / mm)	85x60
LC (Tragkraft / kg)	600
HW (Nabellänge / mm)	60
FL (Einbaulänge / mm)	60
WB (Radlager)	2 Rillen-Kugellager 6005 2RS
BD (Bohrungsdurchmesser / mm)	25