

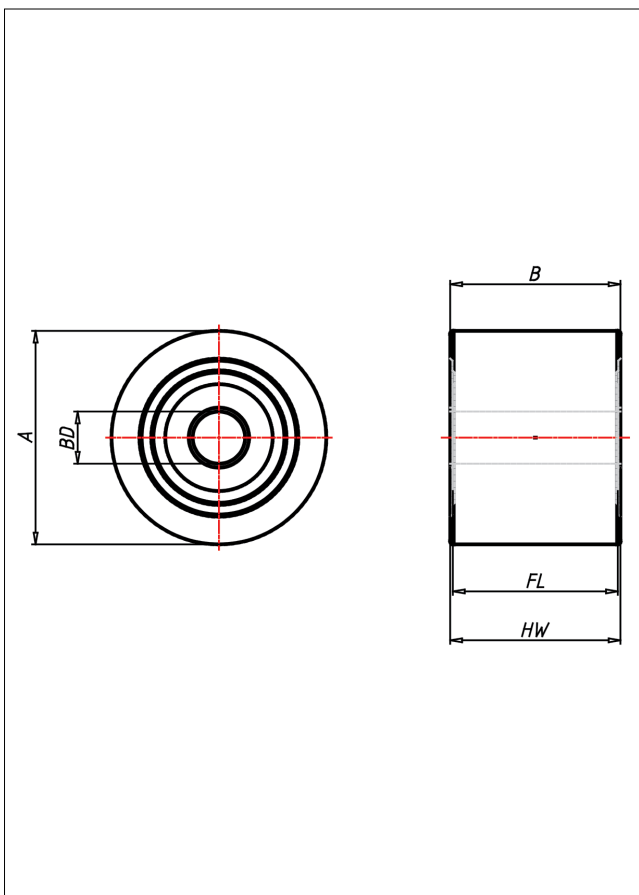

RZ
Rad

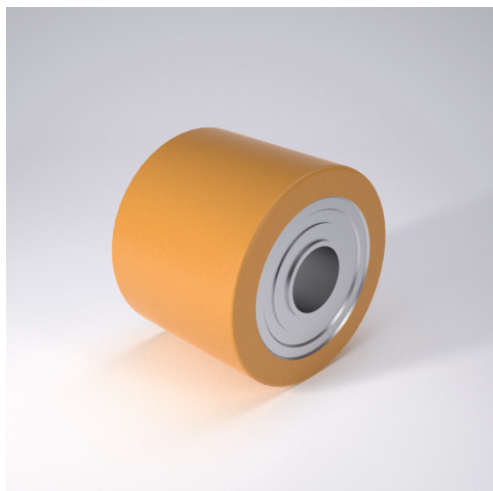

RZ



Radkörper aus Stahl
Laufbelag aus Guss-Polyurethan, 95±3 Shore A

- geräuscharmer Lauf
- geringer Rollwiderstand
- abrieb- und reifest
- hohe Stofestigkeit
- sehr bestndig gegen viele aggressive Medien

Technische Details

ORDERNO (Artikel-nummer)	RZ 75x95 K25
WDAB (Rad-Ø A x Breite B / mm)	75x95
LC (Tragkraft / kg)	720
HW (Nabellnge / mm)	95
FL (Einbaulnge / mm)	91
WB (Radlager)	2 Rillen-Kugellager 6005 ZZ
BD (Bohrungsdurchmesser / mm)	25