

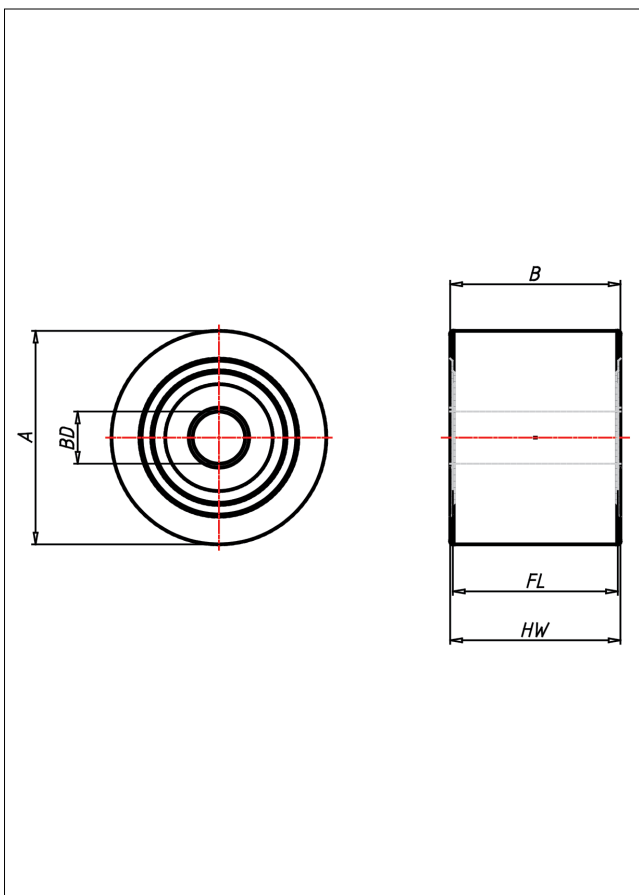

RZ
Rad

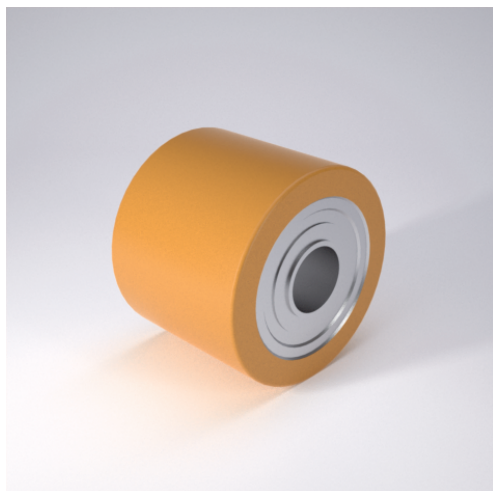

RZ



Radkörper aus Stahl
Laufbelag aus Guss-Polyurethan, 95±3 Shore A

- geräuscharmer Lauf
- geringer Rollwiderstand
- abrieb- und reifest
- hohe Stofestigkeit
- sehr bestndig gegen viele aggressive Medien

Technische Details

| | |
|---------------------------------------|-----------------------------|
| ORDERNO (Artikel-nummer) | RZ 80x70 K20 |
| WDAB (Rad-Ø A x Breite B / mm) | 80x70 |
| LC (Tragkraft / kg) | 700 |
| HW (Nabellnge / mm) | 70 |
| FL (Einbaulnge / mm) | 70 |
| WB (Radlager) | 2 Rillen-Kugellager 6204 ZZ |
| BD (Bohrungsdurchmesser / mm) | 20 |