

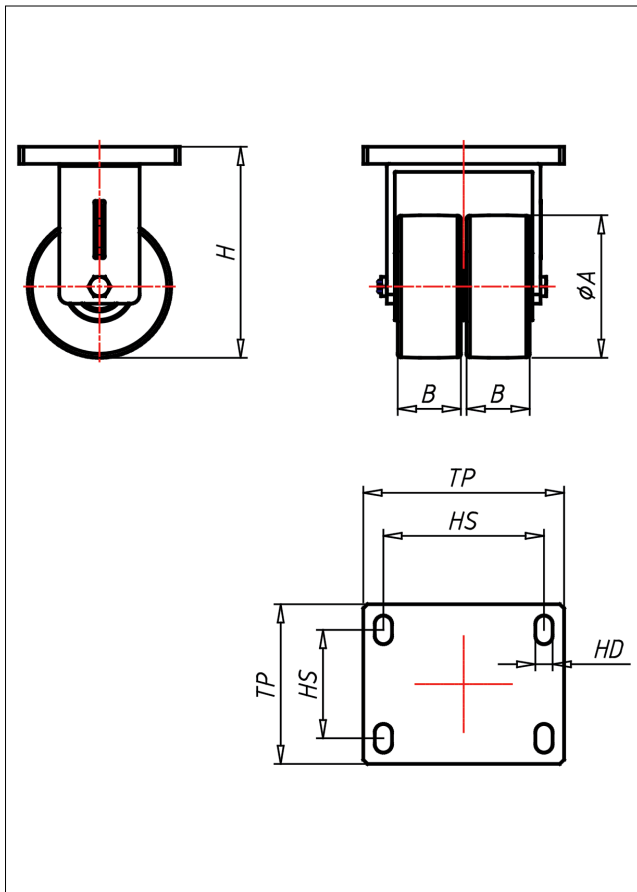

SMMF/SMMSF-PEK

Bockrolle



SMM-PE



LENKROLLE	LENKROLLE MIT TOTALFESTSTELLER	BOCKROLLE																				
<ul style="list-style-type: none"> • für extra schwere Lasten • leichter Lauf auf glatten Böden • stoß- und schlagfest • hohe Abriebfestigkeit • sehr beständig gegen viele aggressive Medien <p>Guss-Polyamid 6 - 1. Wahl → Seite 271</p>	<p>Schrägrollen- und Axialkugellager, staubgeschützt, sehr starker Zentralbolzen, Schmiernippel Ausführung - lackiert → Seite 26</p>	<p>AUSWAHLHILFE:</p> <table border="0"> <tr> <td>leicht lenkend</td> <td>+</td> <td>+</td> <td>+</td> </tr> <tr> <td>verschleißarm</td> <td>+</td> <td>+</td> <td>+</td> </tr> <tr> <td>stoßfest</td> <td>+</td> <td>+</td> <td>+</td> </tr> <tr> <td>bodenschonend</td> <td>+</td> <td>+</td> <td>+</td> </tr> <tr> <td>witterungsbeständig</td> <td>+</td> <td>+</td> <td>+</td> </tr> </table>	leicht lenkend	+	+	+	verschleißarm	+	+	+	stoßfest	+	+	+	bodenschonend	+	+	+	witterungsbeständig	+	+	+
leicht lenkend	+	+	+																			
verschleißarm	+	+	+																			
stoßfest	+	+	+																			
bodenschonend	+	+	+																			
witterungsbeständig	+	+	+																			

Technische Details

ORDERNO (Artikel-nummer)	SMMSF 250 PEK
WDAB (Rad-Ø A x Breite B / mm)	250x80+80
LC (Tragkraft / kg)	5000
H (Bauhöhe H / mm)	330
TP (Plattengröße / mm)	260x200
HS (Lochabstand / mm)	210x160
HD (Loch-Ø / mm)	21
WB (Radlager)	Kugellager