

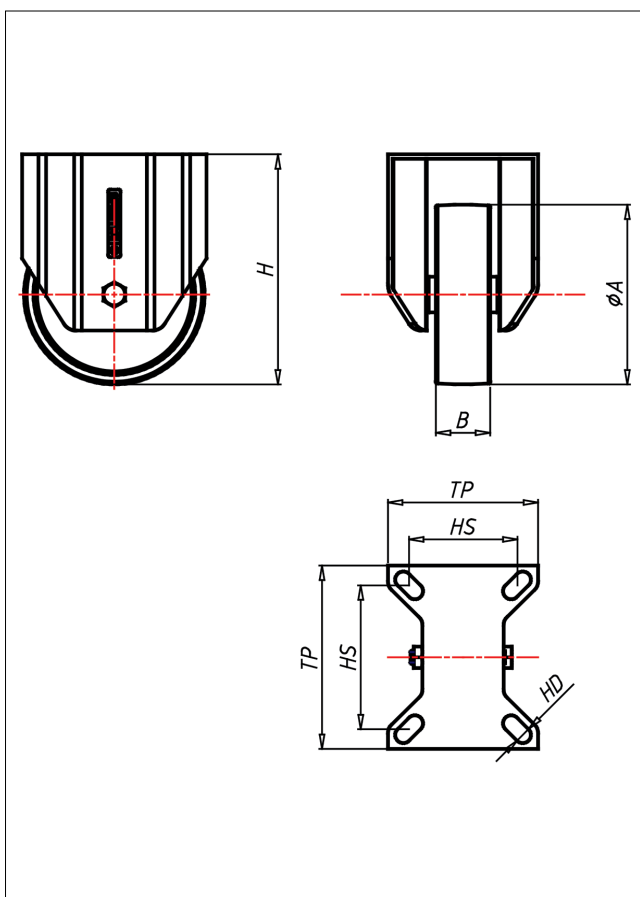

XF/XFS/XFSS-FS

Bockrolle

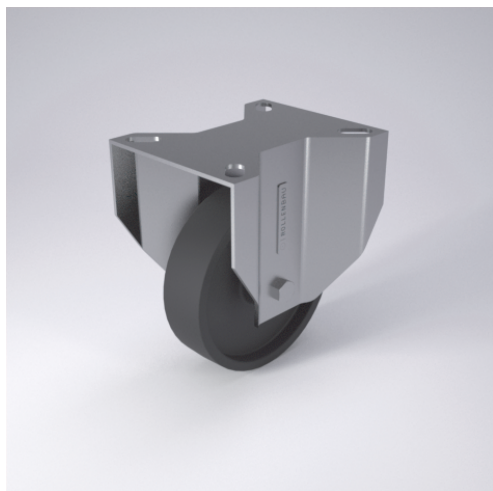

XDH-FS



LENKROLLE		
<ul style="list-style-type: none"> • hitze- und kaltebeständig • leichter Lauf auf glatten Böden • stoß- und schlagfest <p>Monoblockrad schwarz</p> <p>→ Seite 274</p>	<p>zweifaches Kugellager - vernietet, Staubschutzing, Edelstahl AISI 304, Laufkugeln AISI 420, Radachse verschraubt</p> <p>→ Seite 160</p>	<p>AUSWAHLHILFE:</p> <ul style="list-style-type: none"> leicht lenkend verschleißarm stoßfest bodenschonend witterungsbeständig

Technische Details

ORDERNO (Artikel-nummer)	XF 150 FS
WDAB (Rad-Ø A x Breite B / mm)	150x45
LC (Tragkraft / kg)	300
H (Bauhöhe H / mm)	203
TP (Plattengröße / mm)	135x110
HS (Lochabstand / mm)	105x80
HD (Loch-Ø / mm)	11
WB (Radlager)	Gleitlager