

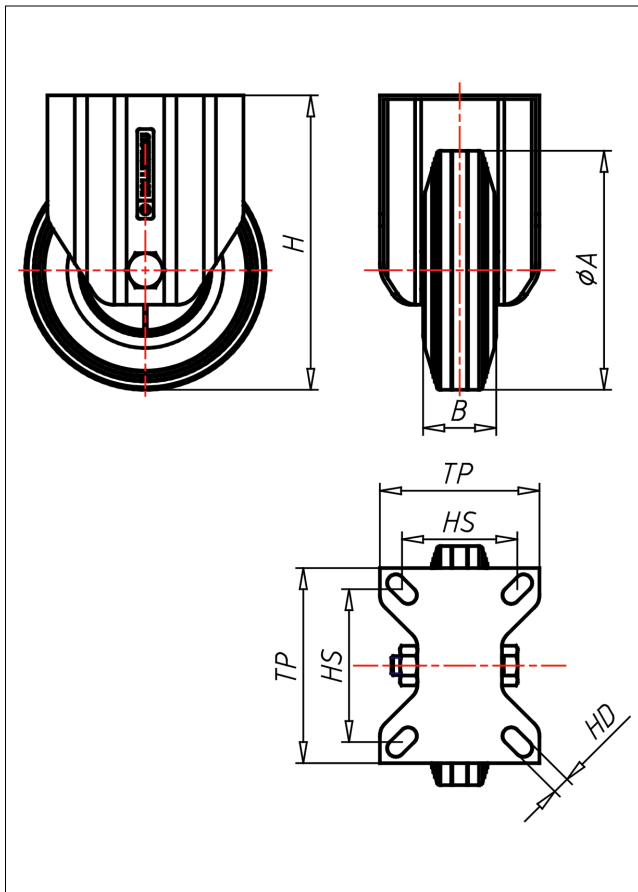

XF/XLF-DGBX/DG

Bockrolle

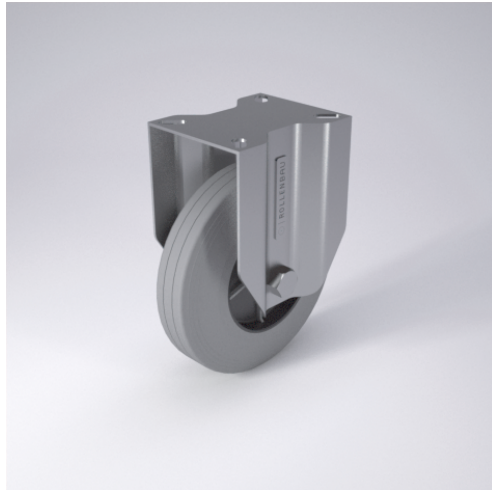

XD-DG



LENKROLLE	LENKROLLE MIT TOTALFESTSTELLER	BOCKROLLE																		
<ul style="list-style-type: none"> • spurfrei - bodenschonend • hoher Fahrkomfort • sehr laufruhig • geringer Rollwiderstand • abriebfest ELASTIK-Vollgummi Felge Kunststoff → Seite 202	 zweifaches Kugellager - vernietet, Edelstahl AISI 304 poliert, Laufkugeln AISI 420, Staubschutzring, Radachse verschraubt → Seite 110	AUSWAHLHILFE: <table border="0"> <tr> <td>-</td><td>+</td><td>++</td></tr> <tr> <td>leicht lenkend</td><td>X</td><td>●</td></tr> <tr> <td>verschleißarm</td><td>●</td><td>X</td></tr> <tr> <td>stoßfest</td><td>X</td><td>●</td></tr> <tr> <td>bodenschonend</td><td>●</td><td>X</td></tr> <tr> <td>witterungsbeständig</td><td>●</td><td>X</td></tr> </table>	-	+	++	leicht lenkend	X	●	verschleißarm	●	X	stoßfest	X	●	bodenschonend	●	X	witterungsbeständig	●	X
-	+	++																		
leicht lenkend	X	●																		
verschleißarm	●	X																		
stoßfest	X	●																		
bodenschonend	●	X																		
witterungsbeständig	●	X																		

Technische Details

ORDERNO (Artikel-nummer)	XF 200 DGBX
WDAB (Rad-Ø A x Breite B / mm)	200x50
LC (Tragkraft / kg)	230
H (Bauhöhe H / mm)	240
TP (Plattengröße / mm)	135x110
HS (Lochabstand / mm)	105x80
HD (Loch-Ø / mm)	11
WB (Radlager)	Rollenlager