

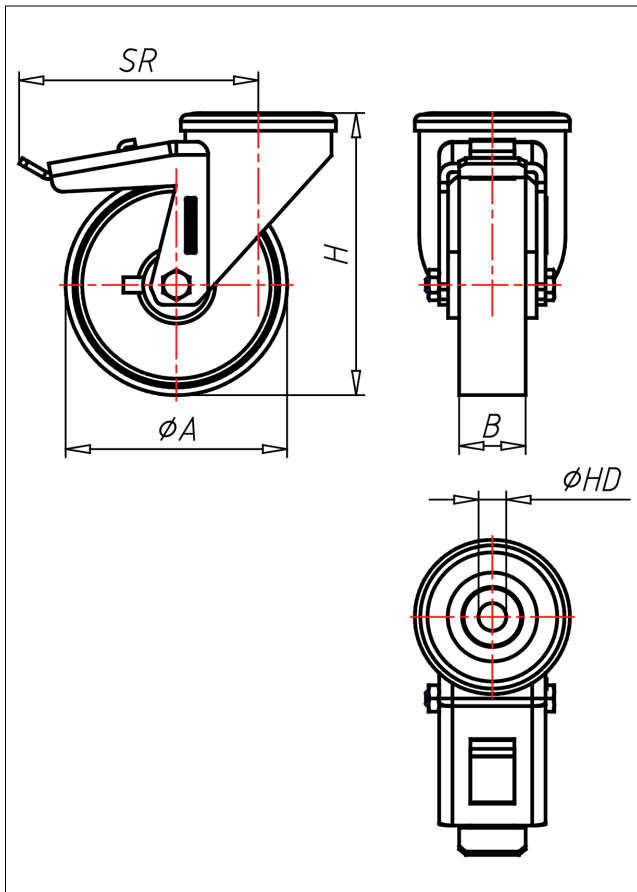





XRT/XRST- PBX/P/PL/PLLBX/PLL

Lenkrolle mit Totalfeststeller



XR-P



LENKROLLE	LENKROLLE MIT TOTALFESTSTELLER	
		
<ul style="list-style-type: none"> • leichter Lauf auf glatten Böden • stoß- und schlagfest • hohe Abriebfestigkeit • leicht zu reinigen • sehr beständig gegen viele aggressive Medien Polyamid 6 - 1. Wahl → Seite 272	 zweifaches Kugellager - vernietet, Staubschutzring, Edelstahl AISI 304 poliert, Laufkugeln AISI 420, Radachse verschraubt → Seite	AUSWAHLHILFE: leicht lenkend <input checked="" type="checkbox"/> <input type="checkbox"/> <input type="checkbox"/> <input type="checkbox"/> verschleißarm <input type="checkbox"/> <input checked="" type="checkbox"/> <input type="checkbox"/> <input type="checkbox"/> stoßfest <input type="checkbox"/> <input type="checkbox"/> <input checked="" type="checkbox"/> <input type="checkbox"/> bodenschonend <input type="checkbox"/> <input type="checkbox"/> <input checked="" type="checkbox"/> <input type="checkbox"/> witterungsbeständig <input type="checkbox"/> <input type="checkbox"/> <input checked="" type="checkbox"/> <input type="checkbox"/>

Technische Details

ORDERNO (Artikel-nummer)	XRT 150 PBX
WDAB (Rad-Ø A x Breite B / mm)	150x40
LC (Tragkraft / kg)	250
H (Bauhöhe H / mm)	181
HD (Loch-Ø / mm)	12.5
SR (Schwenkradius / mm)	140
WB (Radlager)	Rollenlager