

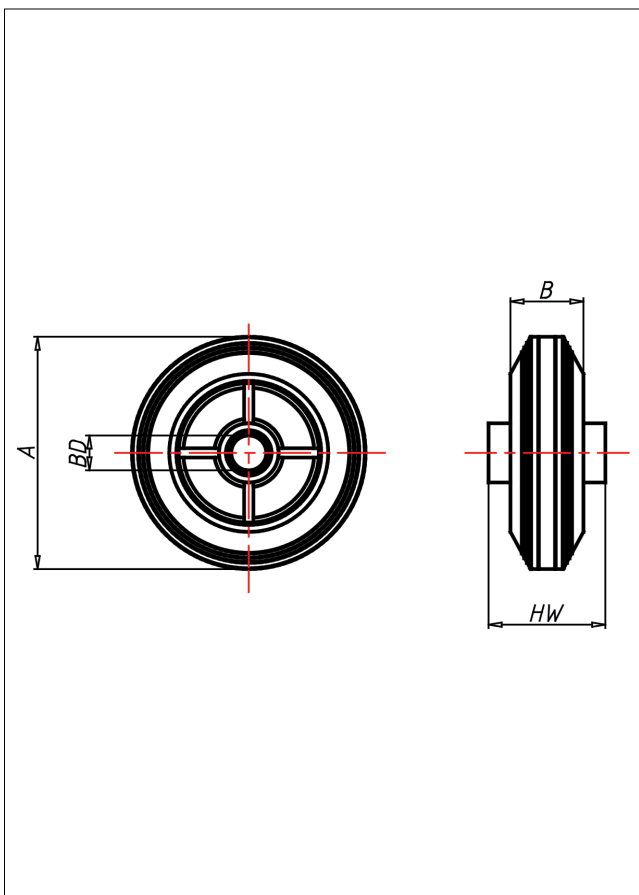

CG Rad

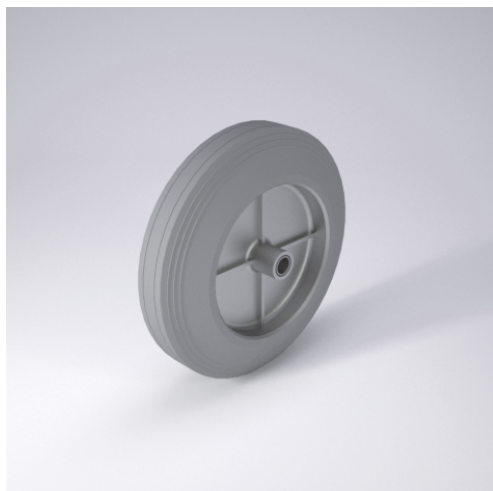

CG



+60 °C
-20 °C max.
200 kg

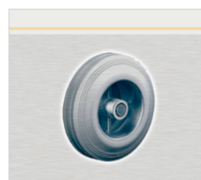

Vernietete Stahlblechfelge, verzinkt
Elastik-Vollgummireifen, grau,
75±5 Shore A

- spurfrei - bodenschonend
- ausgezeichneter Fahrkomfort
- sehr lauffähig
- geringer Rollwiderstand
- abriebfest

Technische Details

ORDERNO (Artikel-nummer)	100 CGK 8
WDAB (Rad-Ø A x Breite B / mm)	100x30
LC (Tragkraft / kg)	90
HW (Nabellänge / mm)	41
FL (Einbaulänge / mm)	41
WB (Radlager)	2 Rillen-Kugellager
BD (Bohrungsdurchmesser / mm)	8